

Effective 1 July 2024



# Residential Home Policy



## Index

Welcome to your Residential Home Policy – insurance for your home	3
Cover Option – Maxi	5
Cover Option – Flexi	18
Exclusions – things we don't cover	23
Making a claim	30
How we'll settle your claim under Cover Option – Maxi	32
How we'll settle your claim under Cover Option – Flexi	36
What your responsibilities are	40
Policy conditions and other important information	43
Definitions	47

### **The online version of this document is interactive**

Click a section on the index page, or any page number in this document, to go straight there.  
To search for a keyword, type Ctrl + F on a PC or Command + F on a Mac.



As part of our commitment to you, this document meets the WriteMark Plain Language Standard. The WriteMark is a quality mark awarded to documents that achieve a high standard of plain language.

# Welcome to your Residential Home Policy – insurance for your home

In this policy wording, we set out what's covered and what's not covered under your policy, your responsibilities, and how we work together with you at claim time.



---

## Who we mean by 'you'

When we say 'you' or 'your', we mean the insured person or people named on your *schedule*, and their partner.

A partner is either a:

- marriage or de facto partner under the Property (Relationships) Act 1976
- civil union partner under the Civil Union Act 2004.

## Who we mean by 'we'

When we say 'we', 'us', or 'our', we mean Vero Insurance New Zealand Limited.

## The documents that make up your insurance policy

Your insurance policy is made up of three parts.

1. This policy wording. It explains what we do and don't cover, the responsibilities you have under the policy, and how to make a claim.
2. Your policy *schedule*. It gives details specific to you, including who and what is insured, and when cover starts and ends. The policy *schedule* also includes any special terms that might apply, which might also detail things that we do and don't cover.
3. The information in your proposal, application, or declaration.

## Read your policy wording, so you know what we do and don't cover

We agree to give you insurance cover as outlined in this policy wording and your policy *schedule*, as long as your *premium* payment is up to date.

Read your insurance policy documents carefully, so you know what you are, and are not, covered for. Keep them together in a safe place.

Once you've read this policy wording, contact your insurance adviser if you would like more information.

## Headings in this policy wording are descriptive

The headings used in this policy wording are descriptive – they're to help you find information. They're not part of the terms and conditions, so you can't rely on them to interpret the policy's meaning.

## Words in italics have specific meanings

When words are in *italics*, they have specific meanings that we've defined in the 'Definitions' section on page 47. When we use these words, we mean the definitions we give in the 'Definitions' section.

## What we cover depends on your cover option

The cover we provide under this policy depends on the cover option on your *schedule*. You'll have either Cover Option – Maxi or Cover Option – Flexi.

## Your home and contents

### Your home

The residential building at the insured address and includes structural improvements, fixtures, fittings and domestic outbuildings.

### Your contents

Includes your furniture, furnishings, valuables, personal possessions and unfixed household goods.

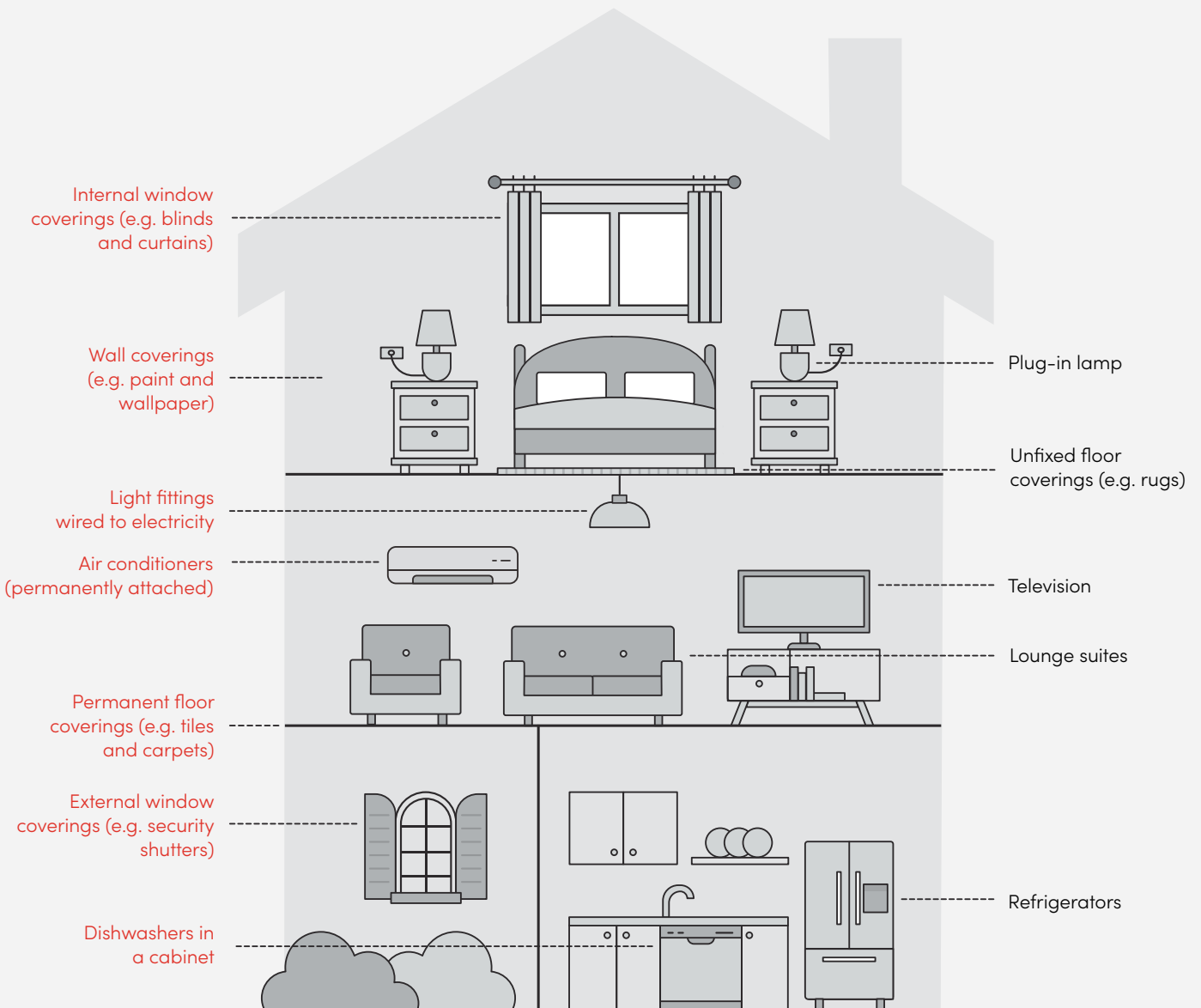

## Cover Option – Maxi

If your *schedule* shows you have Cover Option – Maxi, we'll cover you for *loss* to your *home* at the address on your *schedule*. Any *loss* must happen during the *period of insurance*.

Your cover also includes the benefits below, if the circumstances they outline apply.

Your cover, including the benefits and optional benefits, is subject to the terms, limitations, exclusions, conditions, and cover limits that apply to this policy.

### Benefits we include in your cover

This section explains in detail the benefits we provide, and what we'll pay for each.

✔ paid out of your *sum insured*      + paid in addition to your *sum insured*

BENEFIT	PAGE
+ Alternative accommodation	6
✔ Authorities damage	6
✔ Electronic programmes	6
+ Environmental improvements	7
✔ Gradual damage	7
+ Landscaping	8
✔ Methamphetamine contamination	8
✔ Natural hazard	9
✔ New building work	10
✔ Power generation equipment	10
+ Property owner's liability	11
✔ Resetting or reprogramming your security system	12
✔ Retaining walls	12
✔ Stolen keys	13
+ Stress payment	13
+ SumExtra	14
✔ Temporary removal of fixtures and fittings	14
✔ Tree removal	15
✔ Water or sewage pipe blockage	15

## Alternative accommodation — we'll pay for temporary accommodation if your home is uninhabitable

If you own and live in your *home*, we'll cover your reasonably incurred extra costs for temporary accommodation if you can't live in your *home* because it is *uninhabitable* due to:

- *loss* this policy covers
- *loss* to the *home* that happens during the *period of insurance* that is covered entirely by Toka Tū Ake Natural Hazards Commission (NHC)
- prevention of access to the *home* by government or local authorities which is initiated during the *period of insurance* because of possible or impending damage to an otherwise safe or sanitary *home*.

The temporary accommodation must be of a similar standard to your *home*.

This cover includes boarding your *domestic pets*, storing your *contents*, and moving your *contents* to and from storage or temporary accommodation.

We'll cover up to 12 months of temporary accommodation. If a *natural hazard* causes a widespread event, we may choose to remove the 12-month limit.

For any one event, we'll pay up to 5% of your *sum insured* on your *schedule* or \$30,000, whichever is greater.

### What we won't cover under this benefit

Under this benefit, we won't cover:

- any costs you would normally pay if your *home* was habitable, such as travel, consumables, phone charges, electricity, gas, or water supply services — or any increase in these costs associated with the temporary accommodation
- any costs of alternative premises for your *home office* or *healthcare practice*, or for any other business-related use of your *home*.

### Situations where this benefit won't apply

This benefit will never apply if:

- your *home* is not *uninhabitable* (other than when authorities stop you from accessing your *home* as outlined above)
- we haven't agreed in writing that it's necessary for you to move out of your *home* while it's repaired or rebuilt
- the *loss* covered by NHC is only *loss* to land.

+ Any amount we pay under this benefit, we'll pay in addition to your *sum insured*.

## Authorities damage — we'll cover damage caused to prevent other loss

We'll cover physical damage to your *home* that government or local authorities cause to prevent *loss* that this policy covers.

✓ Any amount we pay under this benefit, we'll pay out of your *sum insured*.

## Electronic programmes — we'll cover resetting electronic equipment in your home

If electronic equipment installed in your *home* suffers *loss* that this policy covers, we'll pay the reasonable cost of resetting, restoring or reprogramming software necessary to use that equipment.

This benefit doesn't cover the loss of any *data* stored on the equipment.

✓ Any amount we pay under this benefit, we'll pay out of your *sum insured*.

## Environmental improvements — we'll pay for home improvements that make your home more environmentally friendly

We'll pay up to \$3,500 for the extra costs associated with buying and installing new environmental improvements to your *home*.

Environmental improvements are alterations or additions to your *home* to help protect or conserve the environment — such as rainwater tanks, solar power systems, and compost equipment.

For you to claim this benefit, all the following circumstances apply.

- We've accepted a claim for *loss* under this policy worth more than 80% of the *sum insured*.
- We're authorising or arranging the repairs to your *home*.
- Your *home* does not already have the environmental equipment.
- We have agreed to the environmental improvements before you buy or install them.

This benefit doesn't cover environmental improvements needed for the repair or rebuilding of your *home* to comply with the latest building regulations, whether or not we actually meet those costs as outlined under the heading 'Statutory requirements' on page 35.

- + Any amount we pay under this benefit, we'll pay in addition to your *sum insured*.

## Gradual damage — we'll cover gradual damage caused by leaking water pipes

We'll pay up to \$3,000 for any one event for the repair of gradual physical damage to your *home* resulting from water leaking or overflowing from any internal water system.

This includes the reasonable cost of searching for the source of the leak or overflow, as long as we've accepted a claim for the gradual damage. We won't pay to repair the actual pipe or vessel that is leaking or overflowing.

We'll only pay if both of the following apply.

- The damage must have first started after you bought the *home*.
- The leak or overflow causing the *loss* wasn't visible, noticeable, or obvious.

An internal water system is either of the following:

- any water pipe, waste disposal pipe, or water storage tank which is permanently connected and contained within the walls, cupboards, floors, ceiling, or roof of the *home*
- any pipe hidden from view that is connected to a water cylinder, refrigerator, water purifier, washing machine, dishwasher, or similar household item that is designed to both receive and release water. An internal water system does not include the appliance itself.

- ✓ Any amount we pay under this benefit, we'll pay out of your *sum insured*.

## Gradual damage

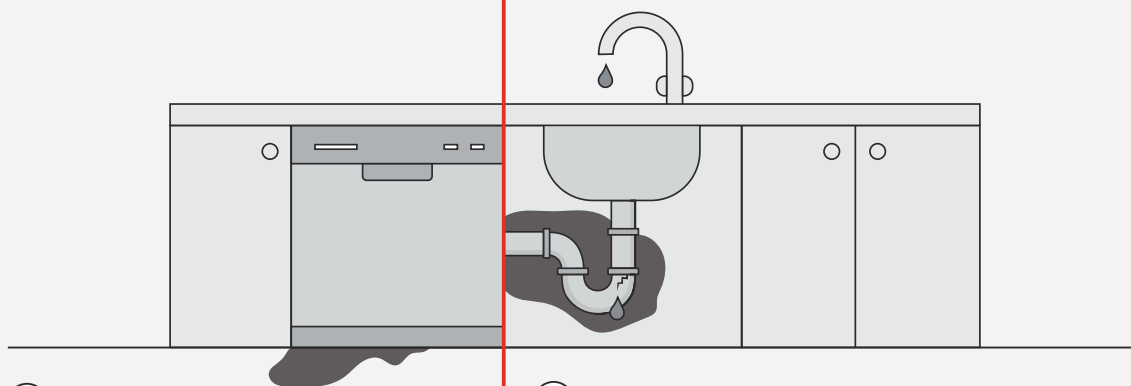

We cover gradual damage resulting from water leaking or overflowing from any internal water system.

We cover reasonable cost of searching for the source of the problem, as long as we have accepted a claim for the gradual damage.

We won't pay to repair the actual pipe or vessel that is leaking or overflowing.

Read the bullets in the 'Gradual damage' benefit on page 7 for a description of the internal water systems we cover.



We won't cover gradual damage caused by water leaking from a hose or pipe that is temporarily connected or is exposed.

## Landscaping — we'll cover your gardens and lawns

We'll pay up to \$5,000 for any one event for damage to your gardens (including hedges, trees, shrubs, and plants), garden edging, and lawns. One of the following must apply.

- The same event also damaged your *home*, and we've agreed to pay a claim for *loss* to your *home*.
- A vehicle that you don't own or weren't in control of caused damage to your gardens, garden edging or lawns by impact, without damaging your *home*. The damage must happen during the *period of insurance*.

+ Any amount we pay under this benefit, we'll pay in addition to your *sum insured*.

## Methamphetamine contamination — we'll cover methamphetamine contamination in rental properties

We'll pay for the testing, decontamination, and repair of your *home* if it suffers *loss* as a result of the use, consumption, storage or manufacture of methamphetamine or its precursor chemicals.

We'll only provide this benefit if all the following apply.

- Your *schedule* shows the *home* is *tenanted*.
- You comply with the Landlord obligations on page 41.
- At the time of the claim, testing confirms that your *home* has a level of chemical contamination that exceeds 15µg (micrograms) per 100cm<sup>2</sup>.
- The people who contaminated the *home* are your *tenants*, or are at the *home* with your *tenants'* permission.

### How we define contamination

We define contamination as a level of chemical contamination that exceeds 15µg (micrograms) per 100cm<sup>2</sup>.



## What we will and won't pay

We'll pay reasonable costs for the following.

- Costs incurred for testing to identify the contamination. We only pay these costs once testing has confirmed contamination.
- Decontamination of the *home* to a level less than 1.5µg/100cm<sup>2</sup>.
- Costs incurred to repair or rebuild a damaged part of your *home* to *replacement condition*, if that is needed to achieve a level less than 1.5µg/100cm<sup>2</sup>.

The most we'll pay is \$50,000 for any one event.

We'll only pay for one claim under this benefit while the *home* is let to the same *tenants*, or under the same *tenancy agreement*.

We won't pay to decontaminate or repair land, even if it's necessary to decontaminate, repair or rebuild your *home* or to comply with government or local authority laws or regulations.

- ✓ Any amount we pay under this benefit, we'll pay out of your *sum insured*.

## Natural hazard – we'll cover natural hazards along with NHC

Toka Tū Ake Natural Hazards Commission (NHC) provides some *natural hazard* cover for homes under the Natural Hazards Insurance Act 2023 (the NHI Act). If *loss* to your *home* is caused by *natural hazard*, any cover under this policy depends upon whether there is cover for your *home* under the NHI Act.

### Loss to parts of your home which NHC insures

Where *loss* to your *home* is caused by *natural hazard*, we'll pay up to a maximum of the difference between these two amounts:

- the cost of repairing or rebuilding your *home*
- the amount payable under the NHI Act

less any *excess* we usually charge.

NHC must have done both of the following:

- accepted liability for your claim
- already paid the maximum under the NHI Act for the *loss*.

We won't cover any:

- *excess* charged by NHC
- *loss* that NHC has determined to be imminent damage under the NHI Act.

### Loss to parts of your home which NHC does not insure

Under the NHI Act, NHC does not insure some parts of your *home*. We'll pay for *loss* caused by *natural hazard* to the following permanently installed items which NHC does not cover:

- drains, pipes, and cables
- driveways, paths, patios, fences, and walls (apart from retaining walls covered by the 'Retaining walls' benefit)
- external swimming or spa pools
- tennis courts.

An additional *excess* of \$5,000 applies to amounts we pay for these parts of your *home*.

### The total you receive for loss caused by natural hazard is limited to your sum insured

The most you will receive for *loss* caused by *natural hazard* from NHC and us combined is your *sum insured*.

All other policy terms and conditions apply to this benefit, along with the basis for settling claims.

- ✓ Any amount we pay under this benefit, we'll pay out of your *sum insured*.

## New building work — we'll cover structures and materials if you do new building work

**!** This benefit is not designed to provide the same cover as a contract works policy.

We'll cover up to \$25,000 during the *period of insurance* for *loss* to new building work from certain causes.

### The new building work that we cover

New building work includes any or all of the following:

- Any new separate structure being built at the address shown on your *schedule*, that you own (or are responsible for while it's being built). The structure must fall within the definition of *home* and be covered by this policy when complete.
- Structural work being done to upgrade existing fittings or features in the *home*.
- Materials at the location shown on the *schedule* that will be part of the new structure.

### The causes of loss that we cover

We cover new building work for *accidental loss* caused by:

- fire, explosion, or lightning
- impact by a vehicle or animal
- impact from aircraft or other aerial or spatial device (like a drone or a satellite), or articles dropped or falling from them
- *natural hazard*
- riot, civil commotion, strikes, or labour disturbance
- storm or *flood* (excluding any exposure to normal weather conditions).

### Circumstances where we don't provide new building work cover

This benefit won't cover structures or work if any of these circumstances apply.

- The expected value of the completed work, or the price of the contract including materials, is more than \$50,000.
- Excavation is more than 1 metre deep.
- An extension, such as an extra *room*, is being added to an existing *home*.
- You're building for commercial purposes.
- You don't have building consent or similar, if it's required.
- The work is covered by a separate contract works insurance policy.

**✓** Any amount we pay under this benefit, we'll pay out of your *sum insured*.

## Power generation equipment — we'll cover wind- or fuel-powered generation equipment

We'll pay up to \$10,000 during the *period of insurance* for *loss* to power generation equipment if it results from any of the following.

- Fire, explosion, or lightning.
- Impact by a vehicle or animal.
- Impact from aircraft or other aerial or spatial device (such as a drone or satellite), or articles dropped from them.
- *Natural hazard*.

This benefit applies if all the following apply:

- You own the power generation equipment.
- It's on land you own, and your *home* is on that same land.
- It provides power to your *home*.

## How we define power generation equipment

Power generation equipment is any wind- or fuel-powered equipment for generating electricity. It includes any support structure, generator, power storage and associated wiring, switching and distribution equipment.

Solar power systems are not covered under this benefit – they're included in your cover as part of your *home*.

- ✓ Any amount we pay under this benefit, we'll pay out of your *sum insured*.

## Property owner's liability – we'll cover your legal liability if you cause loss, damage, or injury

We'll cover you for your legal liability to pay *damages* or *reparation*. We'll only pay if the liability is for *loss* to someone else's property, or *accidental bodily injury*.

The liability must arise from an event that:

- happens during the *period of insurance*
- happens in New Zealand
- results from your ownership of the *home*.

## Landlord's liability – we'll cover an award for bodily injury if you are liable as a landlord under the Health and Safety at Work Act 2015

If you're a landlord, you have responsibilities under the Health and Safety at Work Act 2015. If you fail to meet these responsibilities and a judgment due to *accidental bodily injury* is made against you under the Health and Safety at Work Act 2015, we'll cover the *award* you have to pay. We'll do this as long as you have met the cover requirements above and your *home* is *tenanted*.

## What you must do to claim for liability for reparation

To claim for liability for *reparation*, you must do both of the following.

- Tell us immediately if you're charged with any offence in connection with your ownership of the *home*, which resulted in *bodily injury* to another person or *loss* to someone else's property.
- Obtain our written approval before any offer of *reparation* is made.

## What we won't pay under Property owner's liability and Landlord's liability

We won't pay for any punitive or exemplary damages awarded against you.

We won't pay for legal liability:

- for *loss* to property that you own or that is under your control
- arising from:
  - any business, profession, trade, or employment, except where cover is provided under 'Landlord's liability' above
  - any other activity for financial reward whether for profit or not
  - the ownership, possession or use of any mechanically propelled vehicle, trailer, aircraft, or boat
  - the ownership or possession of any animals, other than *domestic pets*.
- where any exclusion in the 'Exclusions – things we don't cover' section applies (see pages 23 to 29).

We won't cover liability assumed by agreement (unless you would have been liable anyway). But we do cover liability normally agreed to by a landlord under a standard form tenancy or lease agreement.

## Limits on what we'll pay for Property owner's liability and Landlord's liability

For any one event, we'll pay:

- for *loss* to someone else's property, up to \$2,000,000
- for *bodily injury*, up to \$1,000,000.

The most we'll pay during any *period of insurance* is a combined total of \$2,000,000 for all legal liabilities for:

- an *award* (relating to the Health and Safety at Work Act 2015)
- *damages*
- *reparation*.

If you have other insurance with us that may cover liability for the same event, we'll still only pay up to the limits above.

### We also pay legal defence costs if you are legally liable to pay damages

Where you're legally liable to pay *damages*, and we've given you our written agreement beforehand, we'll also pay your legal defence costs and expenses incurred. We won't pay legal defence costs and expenses in relation to an offence, or when you're legally liable to pay *reparation*.

### We also pay legal defence costs if you are legally liable to pay an award

Where you're legally liable to pay an *award* under the Health and Safety at Work Act 2015, and we've given you our written agreement beforehand, we'll also pay your legal defence costs and expenses incurred.

- + Any amount we pay under this benefit, we'll pay in addition to your *sum insured*.

## Resetting or reprogramming your security system — we'll pay to reset your security system after a break-in

We'll pay up to \$500 during the *period of insurance* for the reasonable costs of resetting or reprogramming a security system installed at your *home*.

The security system must have been activated during a break-in or attempted break-in that happened during the *period of insurance*.

- ✓ Any amount we pay under this benefit, we'll pay out of your *sum insured*.

## Retaining walls — we'll cover walls that retain land

We'll cover *loss* to retaining walls. This includes your share in retaining walls that you jointly own with other property owners.

To be covered, the retaining walls must meet all the following criteria.

- Be complete — we don't cover retaining walls unless they were complete, reasonably maintained, and functioning as intended immediately before the *loss* occurred.
- Have the sole purpose of retaining land (meaning their purpose doesn't include repelling water of any kind).
- Had all necessary permits, consents, and certificates from local authorities when they were built, and whenever they were altered.
- Have been damaged in a single *accidental* event — we don't cover gradual damage to retaining walls.

We'll pay for the following things if they are directly necessary for the work to the retaining wall or part of the retaining wall that has suffered *loss*:

- gaining access to the wall
- stabilising the soil
- providing footings and drainage materials.

We'll repair or rebuild the retaining wall to the *replacement condition*.

We won't pay for any undamaged parts of the retaining wall.

The most we'll pay for *loss* to retaining walls is \$80,000 for any one event.

### **We may pay more for retaining walls if they're valued over \$80,000**

We may pay more than \$80,000 to repair or replace retaining walls, if:

- when making a claim you give us a valuation for your property, issued by a qualified valuation or construction expert or professional, like a quantity surveyor, qualified valuer or builder
- the valuation was done before the *loss*
- the valuation separately identifies the replacement value for all retaining walls
- your *sum insured* reflects the total replacement value for your *home* as shown in the valuation.

If all the above circumstances apply, we'll pay up to the value of the retaining walls identified in the valuation.

### **How we define replacement value**

When we say replacement value in this benefit, we mean the amount that would be required to completely rebuild your *home* to the *replacement condition* if your *home* was totally destroyed.

### **We'll top up the cover provided by NHC**

If *loss* to retaining walls arises from *natural hazard*, we'll pay this benefit in addition to cover provided under the Natural Hazards Insurance Act 2023 (the NHI Act).

Toka Tū Ake Natural Hazards Commission (NHC) must have done both of the following:

- accepted liability for your claim for damage to the retaining wall
- already paid the maximum entitlement under the NHI Act for the *loss*.

✔ Any amount we pay under this benefit, we'll pay out of your *sum insured*.

### **Stolen keys — we'll pay to replace stolen keys and re-set keypads**

We'll pay reasonable costs to change or replace locks and keys or change the electronic keypad's entry code, if any of the following happen.

- A key to your *home* is stolen.
- A key to your *home* is believed on reasonable grounds to have been duplicated without your agreement following its disappearance.
- A keypad entry code is shared without your agreement.

We'll also pay the reasonable cost of opening any safe after its key or combination details disappear or are stolen.

We'll pay up to \$2,000 in total for any one event.

✔ Any amount we pay under this benefit, we'll pay out of your *sum insured*.

### **Stress payment — we'll pay you an additional amount if your home is a total loss**

If we pay a *total loss* under this policy, we'll pay you an extra \$5,000 for the stress caused by this *loss*.

⊕ Any amount we pay under this benefit, we'll pay in addition to your *sum insured*.

## SumExtra – we may pay more than the sum insured

Under this benefit, if the *replacement cost* for your *home* is more than the *sum insured*, we'll pay one of the following.

- The part of the *replacement cost* that exceeds the *sum insured*, if the *loss* arises from any cause we cover other than *natural hazard*.
- Up to an extra 10% of the *sum insured* towards the *replacement cost* if the *loss* arises from *natural hazard*.

### Conditions for qualifying for SumExtra

You will qualify for SumExtra if all of the following apply.

1. We settle your claim by paying the *replacement cost* using any of the options numbered 1 to 4, under the heading 'How we settle your claim' under Cover Option – Maxi on page 32.
2. At the time of *loss*, the *sum insured* equals or exceeds a written estimate of costs reasonably necessary to rebuild your *home*. The standard of the rebuild used for the written estimate of costs must:
  - be to a standard or specification similar to, but no better than, your *home's* condition when new
  - use equivalent techniques and building materials readily available in New Zealand.
3. You must have obtained the written estimate of costs from one of the following.
  - The online rebuilding cost calculator on our website, or another online rebuilding cost calculator that we accept.
  - A registered valuer, registered quantity surveyor, building practitioner holding a suitable trade licence, or another building specialist, that we accept.
  - Any other method or source that we accept.
4. The written estimate of costs provides a complete and correct description of your *home* and is less than 3 years old at the time the *sum insured* was most recently agreed – which could be when you purchased the policy, anytime during the *period of insurance*, or at your last renewal.
5. When you make a claim, you must provide us proof of the estimate for rebuilding your *home*, that you obtained before you set your *sum insured*.
6. You may have increased the size or improved the quality of your *home* since you obtained your written estimate of costs. In this case, you must have increased the *sum insured* in line with the increase in the rebuilding cost of your *home*. If you haven't, we'll pay only up to an extra 10% of your *sum insured*. That's regardless of whether the *loss* is caused by *natural hazard* or any other event we insure against.

### How SumExtra affects your cover

This benefit doesn't increase the *sum insured*, or increase any cover that's based on a percentage of the *sum insured*.

- + Any amount we pay under this benefit, we'll pay in addition to your *sum insured*.

## Temporary removal of fixtures and fittings – we'll cover fixtures and fittings while they're away for repairs

We'll pay for *loss* to fixtures and fittings that form part of your *home* while they're with a professional tradesperson or organisation for repair.

This benefit covers the fixtures and fittings while they're removed from your *home* for up to 60 days. The *loss* must happen during the *period of insurance*.

- ✓ Any amount we pay under this benefit, we'll pay out of your *sum insured*.

### Tree removal — we'll pay to remove trees that fall on your home

If we've accepted a claim for *loss* to your *home* caused by a tree or part of a tree falling onto your *home*, we'll pay to remove any part of the tree that's necessary to allow repairs to the *home*.

We'll also pay up to \$2,000 for costs you reasonably incur to remove the rest of the tree from your property. This includes any parts of the tree that haven't fallen.

We won't pay if you knew the tree was unsound or unstable and needed to be removed. We'll never pay to remove stumps from the ground.

- ✓ Any amount we pay under this benefit, we'll pay out of your *sum insured*.

### Water or sewage pipe blockage — we'll cover clearing blockages to underground water and sewage pipes

We'll pay the reasonable cost of clearing an *accidental* blockage in an underground water or sewage pipe.

We'll pay if all the following apply.

- The blockage wasn't caused by the roots of any tree or plant.
- The blockage happened during the *period of insurance*.
- The blocked pipe is within the *residential boundaries* of your *home*.

If clearing the blockage damages part of a driveway, patio, path, paving, tennis court, or other permanent structure that forms part of the *home*, we'll cover the cost of repairing or rebuilding the damaged part.

The maximum we'll pay under this benefit is up to \$1,500 during any one *period of insurance*.

- ✓ Any amount we pay under this benefit, we'll pay out of your *sum insured*.

## Optional benefits – the additional cover you can choose

If you have chosen the following optional benefit, it will appear on your *schedule*.

### Landlord's extension — for tenanted properties

We'll provide the cover below for the number of self-contained dwelling units shown on your *schedule*. All the following must apply.

- You've paid an extra *premium* for this benefit, and your *schedule* shows this benefit is included.
- Each unit has a *tenant* living in it, and is at the address shown on your *schedule*.
- You meet all of the Landlord obligations in the 'What your responsibilities are' section on page 41.

We'll reduce any payment we make under this benefit by any *rent* you received in advance, and any bond that you or Tenancy Services hold, that you could use to compensate the *loss*.

### Landlord's furnishings – we'll pay the indemnity value

We'll pay you the *indemnity value* of *landlord's furnishings*, if they suffer *loss* caused by:

- an event this policy covers
- malicious damage or theft as outlined in the 'Malicious damage or theft' section of this benefit below.

For any one event, we'll pay whichever is higher:

- \$20,000 for *landlord's furnishings* for each dwelling unit that suffers *loss*
- the amount on your *schedule* for *landlord's furnishings*.

### Malicious damage or theft – we'll cover deliberate damage or theft by tenants or their guests

We'll cover you for:

- malicious, intentional, or deliberate damage to the *home*
- theft of any part of the *home*

committed by your *tenants*, or people at the *home* with your *tenants'* permission.

We'll pay either:

- the reasonable cost of rebuilding, repairing, or replacing the damaged part of your *home* to the *replacement condition*
- the *indemnity value*, if you don't decide to have your *home* repaired, rebuilt or replaced within a reasonable time.

The most we'll pay is \$30,000 for any one event. This limit doesn't apply to damage caused by fire or explosion resulting from malicious, intentional, or deliberate damage to the *home* by *tenants* or their guests.

We'll only provide cover under this benefit for *loss* caused by one event while the *home* was let to the same *tenants* or under the same *tenancy agreement*.

### Loss of rent due to loss covered by this policy

We'll pay or reimburse you for loss of *rent* if your *home* is *uninhabitable* for any of the following reasons.

- *Loss* covered by this policy.
- *Loss* that would be covered by this policy but is instead covered by Toka Tū Ake Natural Hazards Commission because of the Natural Hazards Insurance Act 2023.
- Prevention of access to the *home* by government or local authorities which is initiated during the *period of insurance* because of possible or impending damage to an otherwise safe or sanitary *home*.

We'll pay or reimburse you from the date your *home* becomes *uninhabitable*.

We'll provide this benefit if one of the following applies.

- A *tenant* was living in your *home* when it became *uninhabitable*.
- Before your *home* became *uninhabitable*, you had a signed *tenancy agreement* with a new *tenant* to let your *home* continuously for at least 90 days.

We'll pay the average weekly *rent* you received for renting out your *home* while *tenants* were living in it over the 12 months before the *loss*. If you had a *tenancy agreement* signed for a new *tenant* before the *loss*, we'll pay the weekly *rent* in the agreement.

We'll keep paying this benefit for:

- the time necessary to rebuild or repair your *home*, up to 12 months
- up to 2 months if you don't want to repair or rebuild your *home*
- the time during which authorities are preventing access to your *home*, up to 12 months.

For any one event, we'll pay up to whichever is higher:

- \$40,000 for each dwelling unit that is *uninhabitable* and experiencing a loss of *rent*
- the amount on your *schedule* for loss of *rent*.



### Loss of rent due to non-payment by tenants

We'll pay or reimburse you for loss of *rent* if your *tenants* don't pay their *rent* for any of the following reasons.

- Your *tenants* can lawfully move out of your *home* because authorities are preventing access or if public utilities fail. We'll pay up to 8 weeks *rent*.
- Your *tenants* move out of your *home* without giving the required notice. We'll pay up to 8 weeks *rent*.
- You lawfully evict your *tenants* from your *home* because they didn't pay *rent*. We'll pay up to 12 weeks *rent*.
- The Tenancy Tribunal orders your *tenants* to leave your *home* and the tenancy to end. We'll pay up to 12 weeks *rent* if you or your property manager have enforced the order within 5 working days of it being issued.

Loss of *rent* is calculated from the date unpaid *rent* was first due until either the *home* is re-*tenanted*, or we have paid the maximum number of weeks *rent* that applies to the reason your *tenants* have stopped paying — as explained above.

## Cover Option – Flexi

If your *schedule* shows you have Cover Option – Flexi, we'll cover you for specific types of *loss* to your *home* at the address on your *schedule*. Any *loss* must happen during the *period of insurance* and arise only from the following events.

- Breakage of any gas pipes, fresh-water pipes, underground water and septic tanks, underground drainage and sewerage pipes, electricity, data, or telephone cables.
- Breakage of fixed glass or porcelain forming part of your *home*.
- Burglary or theft.
- Burning out by electrical current.
- Collision or impact by vehicle or animal.
- Fire, explosion, or lightning.
- Impact from aircraft or other aerial or spatial devices, or items or debris dropped from them.
- Malicious damage or vandalism.
- *Natural hazard*.
- Plumbing installations freezing in your *home*, except for installations outside or in outbuildings or detached garages.
- Possums entering your *home*.
- Riots, civil commotion, strikes, or labour disturbance.
- Storm or *flood*.
- Water or oil suddenly escaping or overflowing from any domestic water or heating equipment, sink, bath, toilet, or pipes installed in your *home*.

Your cover also includes the benefits below, if the circumstances they outline apply.

Your cover, including the benefits and optional benefits, is subject to the terms, limitations, exclusions, conditions, and cover limits that apply to this policy.

### Benefits we include in your cover

This section explains in detail the benefits we provide, and what we'll pay for each.

- ✓ paid out of your *sum insured*     
 + paid in addition to your *sum insured*

BENEFIT	PAGE
<span>+</span> Alternative accommodation	19
<span>✓</span> Authorities damage	19
<span>+</span> Landscaping	19
<span>✓</span> Natural hazard	20
<span>+</span> Property owner's liability	20

## Alternative accommodation — we'll pay for temporary accommodation if your home is uninhabitable

If you own and live in your *home*, we'll cover your reasonably incurred extra costs for temporary accommodation if you can't live in your *home* because it is *uninhabitable* due to:

- *loss* this policy covers
- *loss* to the *home* that happens during the *period of insurance*, that is covered entirely by Toka Tū Ake Natural Hazards Commission (NHC)
- prevention of access to the *home* by government or local authorities which is initiated during the *period of insurance* because of possible or impending damage to an otherwise safe or sanitary *home*.

The temporary accommodation must be of a similar standard to your *home*.

This cover includes boarding your *domestic pets*, storing your *contents*, and moving your *contents* to and from storage or temporary accommodation.

We'll cover up to 12 months of temporary accommodation. If a *natural hazard* causes a widespread event, we may choose to remove the 12-month limit.

For any one event, we'll pay up to 5% of your *sum insured* on your *schedule* or \$30,000, whichever is greater.

### What we won't cover under this benefit

Under this benefit, we won't cover:

- any costs you would normally pay if your *home* was habitable, such as travel, consumables, phone charges, electricity, gas, or water supply services— or any increase in these costs associated with the temporary accommodation.
- any costs of alternative premises for your *home office* or *healthcare practice*, or for any other business-related use of your *home*.

### Situations where this benefit won't apply

This benefit will never apply if:

- your *home* is not *uninhabitable* (other than when authorities stop you from accessing your *home* as outlined above)
- we haven't agreed in writing that it's necessary for you to move out of your *home* while it's repaired or rebuilt
- the *loss* covered by NHC is only *loss* to land.

+ Any amount we pay under this benefit, we'll pay in addition to your *sum insured*.

## Authorities damage — we'll cover damage caused to prevent other loss

We'll cover physical damage to your *home* that government or local authorities cause to prevent *loss* that this policy covers.

✓ Any amount we pay under this benefit, we'll pay out of your *sum insured*.

## Landscaping — we'll cover your gardens and lawns

We'll pay up to \$2,500 for any one event for damage to your gardens (including hedges, trees, shrubs, and plants), garden edging, and lawns. One of the following must apply.

- The same event also damaged your *home*, and we've agreed to pay a claim for *loss* to your *home*.
- A vehicle that you don't own or weren't in control of causes damage to your gardens, garden edging or lawns by impact during the *period of insurance*, without damaging your *home*.

+ Any amount we pay under this benefit, we'll pay in addition to your *sum insured*.

## Natural hazard – we’ll cover natural hazards along with NHC

Toka Tū Ake Natural Hazards Commission (NHC) provides some *natural hazard* cover for homes under the Natural Hazards Insurance Act 2023 (the NHI Act). If *loss* to your *home* is caused by *natural hazard*, any cover under this policy depends upon whether there is cover for your *home* under the NHI Act.

### Loss to parts of your home which NHC insures

Where *loss* to your *home* is caused by *natural hazard*, we’ll pay up to a maximum of the difference between these two amounts:

- the *indemnity value* of your *home*
- the amount payable under the NHI Act

less any *excess* we usually charge.

NHC must have done both of the following:

- accepted liability for your claim
- already paid the maximum under the NHI Act for the *loss*.

We won’t cover any:

- *excess* charged by NHC
- *loss* that NHC has determined to be imminent damage under the NHI Act.

### Loss to parts of your home which NHC does not insure

Under the NHI Act, NHC does not insure some parts of your *home*. We’ll pay for *loss* caused by *natural hazard* to the following permanently installed items which NHC does not cover:

- drains, pipes, and cables
- driveways, paths, patios, fences, and walls
- external swimming or spa pools
- tennis courts.

An additional *excess* of \$5,000 applies to amounts we pay for these parts of your *home*.

### The total you receive for loss caused by natural hazard is limited to your sum insured

The most you will receive for *loss* caused by *natural hazard* from NHC and us combined is your *sum insured*.

All other policy terms and conditions apply to this benefit, along with the basis for settling claims.

- ✓ Any amount we pay under this benefit, we’ll pay out of your *sum insured*.

## Property owner’s liability – we’ll cover your legal liability if you cause loss, damage, or injury

We’ll cover you for your legal liability to pay *damages* or *reparation*. We’ll only pay if the liability is for *loss* to someone else’s property, or *accidental bodily injury*.

The liability must arise from an event that:

- happens during the *period of insurance*
- happens in New Zealand
- results from your ownership of the *home*.

### Landlord’s liability – we’ll cover an award for bodily injury if you are liable as a landlord under the Health and Safety at Work Act 2015

If you’re a landlord, you have responsibilities under the Health and Safety at Work Act 2015. If you fail to meet these responsibilities and a judgment for *accidental bodily injury* is made against you under the Health and Safety at Work Act 2015, we’ll cover the *award* you have to pay. We’ll do this as long as you have met the cover requirements above and your *home* is *tenanted*.

### What you must do to claim for liability for reparation

To claim for liability for *reparation*, you must do both of the following.

- Tell us immediately if you're charged with any offence in connection with your ownership of the *home*, which resulted in *bodily injury* to another person or *loss* to someone else's property.
- Obtain our written approval before any offer of *reparation* is made.

### What we won't pay under Property owner's liability and Landlord's liability

We won't pay for any punitive or exemplary damages awarded against you.

We won't pay for legal liability:

- for *loss* to property that you own or that is under your control
- arising from:
  - any business, profession, trade, or employment, except where cover is provided under 'Landlord's liability' above
  - any other activity for financial reward whether for profit or not
  - the ownership, possession or use of any mechanically propelled vehicle, trailer, aircraft, or boat
  - the ownership or possession of any animals, other than *domestic pets*.
- where any exclusion in the 'Exclusions – things we don't cover' section applies (see pages 23 to 29).

We won't cover liability assumed by agreement (unless you would have been liable anyway). But we do cover liability normally agreed to by a landlord under a standard form tenancy or lease agreement.

### Limits on what we'll pay for Property owner's and Landlord's liability

For any one event, we'll pay:

- for *loss* to someone else's property, up to \$2,000,000
- for *bodily injury*, up to \$1,000,000.

The most we'll pay during any *period of insurance* is a combined total of \$2,000,000 for all legal liabilities for:

- an *award* (relating to the Health and Safety at Work Act 2015)
- *damages*
- *reparation*.

If you have other insurance with us that may cover liability for the same event, we will still only pay up to the limits above.

### We also pay legal defence costs if you are legally liable to pay damages

Where you're legally liable to pay *damages*, and we've given you our written agreement beforehand, we'll also pay your legal defence costs and expenses incurred. We won't pay legal defence costs and expenses in relation to an offence, or when you're legally liable to pay *reparation*.

### We also pay legal defence costs if you are legally liable to pay an award

Where you're legally liable to pay an *award* under the Health and Safety at Work Act 2015, and we've given you our written agreement beforehand, we'll also pay your legal defence costs and expenses incurred.

- ⊕ Any amount we pay under this benefit, we'll pay in addition to your *sum insured*

## Optional benefits – the additional cover you can choose

If you have chosen the following optional benefit, it will appear on your *schedule*.

### Landlord's extension — for tenanted properties

We'll provide the cover below for number of self-contained dwelling units shown on your *schedule*. All the following must apply.

- You've paid an extra *premium* for this benefit, and your *schedule* shows this benefit is included.
- Each unit has a *tenant* living in it, and is at the address shown on your *schedule*.

### Landlord's furnishings – we'll pay the indemnity value

We'll pay you the *indemnity value* of *landlord's furnishings* if they suffer *loss* caused by an event this policy covers.

For any one event, we'll pay up to \$5,000 for *landlord's furnishings* for each dwelling unit that suffers *loss*.

### Loss of rent due to loss covered by this policy

We'll pay or reimburse you for loss of *rent* if your *home* is *uninhabitable* for any of the following reasons.

- *Loss covered by this policy.*
- *Loss* that would be covered by this policy but is instead covered by Toka Tū Ake Natural Hazards Commission because of the the Natural Hazards Insurance Act 2023.
- Prevention of access to the *home* by government or local authorities which is initiated during the *period of insurance* because of possible or impending damage to an otherwise safe or sanitary *home*.

We'll pay or reimburse you from the date your *home* becomes *uninhabitable*.

We'll provide this benefit if one of the following applies.

- A *tenant* was living in your *home* when it became *uninhabitable*.
- Before your *home* became *uninhabitable*, you had a signed *tenancy agreement* with a new *tenant*, to let your *home* continuously for at least 90 days.

We'll pay the average weekly *rent* you received for renting out your *home* while *tenants* were living in it over the 12 months before the *loss*. If you had a *tenancy agreement* signed for a new *tenant* before the *loss*, we'll pay the weekly *rent* in the agreement.

We'll also pay any other costs incurred with our written permission.

We'll keep paying this benefit for:

- the time necessary to rebuild or repair your *home*, up to 12 months
- up to 2 months if you don't want to repair or rebuild your *home*
- the time authorities are preventing access to your *home*, up to 12 months.

For any one event, we'll pay up to whichever is higher:

- \$20,000 for each dwelling unit that is *uninhabitable* and experiencing a loss of *rent*
- the amount on your *schedule* for loss of *rent*.

## Exclusions – things we don't cover

We won't cover you in these situations. These exclusions apply whether you have Cover Option – Maxi or Cover Option – Flexi.

### Asbestos

We won't cover any *loss* caused by, arising from, or in any way connected to asbestos.

We also won't cover legal liability resulting from any direct, indirect, or potential exposure to asbestos.

However, we'll pay the cost to remove asbestos from the *home* during repairs or rebuilding if we have accepted a claim for *loss* or damage to your *home*.

We'll only cover the removal of asbestos from the immediate area of the *home* that has suffered the *loss* or damage.

### Business use

We won't cover any *loss* or liability arising from your *home* being used for business.

This exclusion doesn't apply to:

- any part of the *home* used as a *home office* or *healthcare practice*
- *loss* arising from any other business-related use of your *home* that we've agreed to and is shown on your *schedule*.

### Communicable disease

We won't cover any *loss*, damage, interruption, liability, claim, cost, expense or any other sum of any kind that arises directly or indirectly out of, is contributed to by, or is in connection with any of the following.

1. Communicable disease.
2. The actual, or perceived, fear or threat of communicable disease.
3. Actions by any person, entity or public authority to respond to, control, prevent or suppress communicable disease.

Any other sum of any kind also includes any increased or additional costs or expenses of a claim that this exclusion does not otherwise apply to.

This exclusion:

- takes priority over any other term in this policy or any endorsement (including any that might contradict it)
- applies regardless of any other cause or event contributing at the same time or in any other order to 1–3 above.

When we say communicable disease, we mean any of these things.

- Any human, animal, plant or other disease that can be transmitted directly or indirectly from any organism to another organism by means of any substance or agent, including without limitation, any:
  - virus
  - bacterium
  - parasite
  - other organism
  - any variation of any of the above, whether living or not.
- Any Infectious Disease or Quarantinable Disease as defined in or declared under the Health Act 1956.

## Confiscation

We won't cover *loss*, damage, or liability in any way connected with confiscation, acquisition, designation, destruction or decision by government or local authorities.

## Consequential loss

We won't cover any intangible or consequential loss of any kind, including:

- loss of use
- loss of enjoyment
- loss of value.

## Costs to mitigate loss

We won't cover any costs directly or indirectly arising from either of the following, even if they're necessary to prevent or lessen *loss* to your *home*.

- Stabilising or improving land.
- Erecting or upgrading any improvements to land.

## Criminal or reckless activity

We won't cover any *loss*, damage, cost, or liability in any way connected with:

- criminal activity involving anything this policy covers, unless you prove that you didn't have reason to suspect that criminal activity was happening
- any deliberate, intentional, knowing, wilful or reckless act, or failure to act, whether criminal or otherwise, committed by you, or anyone this policy covers.

## Cyber acts and incidents

We won't cover any *loss*, damage, liability, cost, or expense in any way connected to a *cyber act* or *cyber incident*. This exclusion does not apply if a *loss* covered by this policy causes a *cyber incident*.

However, if there's resulting *loss* to other parts of the *home* caused by a *cyber act* or *cyber incident*, we'll cover it (unless it's excluded under another part of this policy).

## Damage by insects and vermin

We won't cover *loss* caused by insects or vermin – except possums.

However, if there's resulting *loss* to other parts of the *home* caused by the excluded *loss*, we'll cover it (unless it's excluded under another part of this policy).

## Damage during cleaning, repair, renovation, or restoration

We won't cover any *loss* caused by any cleaning process, renovation, repair, or restoration – but this only excludes:

- the part of the *home* that has directly undergone that process
- any other part of the *home* in any way physically connected to the part of the *home* that has undergone that process.

This exclusion doesn't limit cover under the 'New building work' benefit.

However, if there's resulting *loss* to other parts of the *home* caused by any cleaning process, renovation, repair, or restoration, we'll cover it (unless it's excluded under another part of this policy).



## Data

We won't cover any *loss*, damage, liability, cost, or expense of any kind in any way connected to:

- *data* being totally or partially destroyed, distorted, erased, corrupted, altered, misinterpreted, or misappropriated
- errors in creating, amending, entering, deleting, or using *data*
- total or partial inability or failure to receive, send, access, or use *data* for any time
- any loss of use of *data*, or *data* being reduced in functionality, repaired, replaced, restored, or reproduced
- the value of any *data*.

This exclusion applies whether any other causes or events contribute at the same time, or in any order, to any of the above.

## Defective workmanship

We won't cover *loss* caused by poor or defective workmanship.

However, if there's resulting *loss* to other parts of the *home* caused by the excluded *loss*, we'll cover it (unless it's excluded under another part of this policy).

## Defects

We won't cover *loss* caused by any defect in design or inherent fault.

However, if there's resulting *loss* to other parts of the *home* caused by the excluded *loss*, we'll cover it (unless it's excluded under another part of this policy).

## Deliberate damage by people living in your home

We won't cover *loss* caused by burglary, theft, malicious, or deliberate damage committed by anyone renting, living, or staying in your *home*.

However, if your *home* is *tenanted*, we'll cover any *loss* from fire or explosion caused by malicious, intentional, or deliberate damage by *tenants*.

This exclusion doesn't apply to cover under the 'Landlord's extension' optional benefit, but only if:

- your *home* is *tenanted*
- your *schedule* shows you have Cover Option – Maxi and the 'Landlord's extension' optional benefit.

## Excesses

We won't cover any *excesses*.

## Fire and Emergency Act 2017

We won't cover you where your liability arises directly or indirectly from any fire you intentionally lit that didn't comply with either:

- the Fire and Emergency Act 2017
- any other statutory or local body requirements governing the lighting of fires.

## Gradually operating causes

We won't cover *loss* caused by the action of micro-organisms, mould, mildew, rot, fungi, or any other gradual cause.

We won't cover *loss* caused by corrosion or rust.

This exclusion doesn't limit cover under the 'Gradual damage' benefit.

## Home defects

We won't cover any *loss* to your *home* that is in any way connected to your *home* failing to include:

- materials
- a design
- a system
- or standard of workmanship

that effectively prevents or manages the presence or penetration of moisture or water that your *home* might be reasonably subjected to.

## Household pets

We won't cover *loss* caused by any pets scratching, chewing, tearing, or soiling.

This exclusion only applies if you don't live in your *home*.

## Hydrostatic pressure

We won't cover any *loss* to swimming and spa pools caused by hydrostatic pressure.

## Illegal drug contamination

We won't cover *loss* or liability arising from anyone making, supplying, storing, possessing, or using any illegal drugs or substances in or near your *home*.

This exclusion also applies to any precursor chemicals or materials used in the making, supplying, storing, possessing, or use of illegal drugs or substances.

However, we'll cover any *loss* to your *home* from fire or explosion.

## We'll provide some cover if you have Cover Option – Maxi

If your *schedule* shows you have Cover Option – Maxi, this exclusion doesn't apply in either of the following circumstances.

- Your *home* is *tenanted*, and we cover you under the 'Methamphetamine contamination' benefit.
- You normally live in your *home*, and *loss* is caused by unknown people entering your *home* without your permission while it's unattended (but not *unoccupied*). We'll extend the 'Methamphetamine contamination' benefit to cover the *loss*, and this exclusion won't apply to that cover. The limit for what we pay for the 'Methamphetamine contamination' benefit won't apply. Instead, we'll pay within the *sum insured*.

## Land

We won't cover any of the following.

- Land.
- *Loss* to land.
- Repairing or stabilising land so you can repair or rebuild your *home*.
- Treating land so it's suitable for repairing or building your *home*.
- Any costs in any way connected with stabilising or making improvements to land, or erecting or upgrading any improvements to land, which are needed to prevent or reduce *loss* to the *home*.
- *Loss* that is in any way connected with subsidence, settling, ground heave, shrinkage, or expansion.

- *Loss* that is in any way connected with erosion arising from action of wind or water. Erosion includes but is not limited to:
  - erosion landslides
  - coastal erosion
  - bank erosion
  - sheet erosion.
- *Loss* in any way connected with land, where you know the land needs repair or you know the land poses a threat to the *home*.
- *Loss* in any way connected with the condition of the land if you, or a previous owner of the *home*, have received money from Toka Tū Ake Natural Hazards Commission (formerly the Earthquake Commission) to repair the land, but not done so.

We'll only cover work to land if it's either:

- work we cover under the 'Retaining walls' benefit
- digging foundations or piles which are both:
  - necessary to allow for the repair or rebuild of your *home* after a *loss* we cover
  - required by government or local authority statutes, bylaws, or regulations.

You must ensure your land provides an acceptable platform for any repairing or rebuilding of your *home* that we cover.

## Lifting, moving, or relocating your home

We won't cover *loss* that is in any way connected with lifting or moving your *home* (including while in transit or storage, and while placed on temporary blocks or supports before, during, or after relocation).

We also won't cover any costs associated with relocating your *home*.

## Loss that's covered by ACC

We won't cover any amount that anyone (including the victim of an offence) can claim under the Accident Compensation Act 2001. This includes if:

- the victim hadn't made an ACC claim, or didn't make an ACC claim within the time required under the Act
- ACC declined the claim or limited their liability for any reason.

## Mechanical or electrical breakdown

We won't cover *loss* caused by either:

- mechanical or electrical breakdown
- inability to operate any mechanical or electrical device this policy covers.

This exclusion doesn't apply to *loss* caused by actual burning out as a direct result of an *accidental* external cause, or if the *loss* arises from:

- impact
- earthquake or *flood*
- fire or lightning
- an external power surge that originated outside of the *home*
- volcanic activity
- malicious acts.

We never cover *loss* where arcing occurs in the ordinary working of any lighting or heating element, fuse, protective device, or electronic contact.

However, if there's resulting *loss* to other parts of the *home* caused by the excluded *loss*, we'll cover it (unless it's excluded under another part of this policy).

## Natural hazard

We won't cover *loss* in any way connected with any of these:

- earthquakes or natural landslides
- volcanic activity or hydrothermal activity
- tsunami
- fire resulting from any of the above.

This exclusion doesn't limit cover under the 'Natural hazard' or 'Retaining walls' benefits.

## Nuclear activity

We won't cover *loss*, damage, or liability in any way connected with nuclear weapons, ionising radiation, or contamination by radioactivity from nuclear fuel, or the combustion of waste from nuclear fuel.

## Pre-existing damage

We won't cover any pre-existing damage.

## Sanctions

We won't provide any cover, service, or benefit, or pay anything in connection with your policy, including any *premium* refund, if doing so may breach or risk exposure to any of the following.

1. Penalties, sanctions, prohibitions, proscriptions, preventions, or restrictions under United Nations resolutions.
2. Sanctions, proscriptions, preventions, laws or regulations of New Zealand, Australia, the United Kingdom, the United States of America, or the European Union.

## Some events in the first 72 hours of this policy

We won't cover any *loss* that happens during the first 72 hours of the policy, if the *loss* is caused by storm, *flood*, landslide, bush fire or volcanic activity.

This exclusion only applies when you first take out this policy. This exclusion doesn't apply if either:

- this policy starts immediately after another policy that insures your *home* against storm, *flood*, landslide, bush fire or volcanic activity
- you took out this policy when you first bought your *home*.

## Structural changes we haven't agreed to

We won't cover *loss* caused by either of the following.

- Adding to or changing the structure of your *home*, unless the 'New building work' benefit applies.
- Removing any external walls, roofing, external cladding, windows, or doors.

We'll cover you if you told us about the work before it began, and we agreed in writing to keep covering you.

## Terrorism

We won't cover *loss*, damage, or liability in any way connected with any act of terrorism. This includes any act of terrorism in any way connected to pollution, contamination, or explosion that is:

- biological
- chemical
- radioactive
- nuclear.

An act of terrorism means any act which:

- may include the use of force or violence, or the threat of its use; and
- is carried out or arranged by any person or group(s) of people, whether acting alone or on behalf of or in connection with any organisation(s) or government(s).

From its nature or context, the act:

- is done for, or in connection with, political, religious, ideological, ethnic or similar purposes; and
- may include the intention to influence any government or to put fear in the public or any section of the public.

## Uncertified home

We won't cover any *loss* that's in any way connected to your *home* failing to meet the standard that any regulation, Act, or bylaw prescribes.

## Unoccupied homes

We won't cover any *loss* to your *home* while your *home* is:

- *unoccupied*
- unattended, if you normally use it as a holiday *home* or weekend *home*.

However, we'll cover your *home* if we know the *home* is a holiday *home*, or we agreed in writing to cover you while your *home* was *unoccupied*.

All of the following must be met.

- Your *home*, its lawns, and its gardens are kept tidy.
- All external doors and windows are kept locked.
- All papers and mail are collected regularly.
- Your *home* is under regular supervision.

If you normally live in your *home*, but your travel or medical commitments mean it's *unoccupied* for more than 60 days, we'll keep covering it for an additional 30 days. You must still meet the conditions above.

## Vibration

We won't cover *loss* caused by vibration, weakening of support, or removal of support.

## War

We won't cover *loss*, damage, or liability in any way connected with:

- war
- invasion
- acts of foreign enemies
- hostilities or warlike operations (whether war is declared or not)
- civil war
- civil commotion assuming proportions of or amounting to an uprising
- military uprising
- popular uprising
- mutiny
- rebellion
- revolution
- insurrection
- military or usurped power.

## Wear and tear

We won't cover *loss* caused by wear and tear.

However, if there's resulting *loss* to other parts of the *home* caused by the excluded *loss*, we'll cover it (unless it's excluded under another part of this policy).

## Making a claim

If something happens and you think you may need to make a claim, first make sure everyone is safe.

Then, contact your insurance adviser or us as soon as possible.

Once we have all the information we need, we'll decide the best way to advance your claim.

### What you must do if something happens that might lead to a claim

If anything happens that might lead to a claim under this policy, you must do all the following.

- Tell the Police if there's been theft, burglary, or vandalism.
- Tell your insurance adviser or us about what's happened.
- Take all reasonable steps to minimise the *loss*.
- Send us any communications you get about an event that might lead to a claim.
- Obtain our permission before you start repairs (unless you're replacing or repairing window glass).
- Let us inspect any damaged property.
- Provide us any information or help we may need, including proof that you own the property you're claiming for.
- Help us take any recovery action we choose against anyone we consider responsible for the *loss*.
- At your cost, cooperate with our assessors, investigators, lawyers, and anyone else we appoint to help us. This includes attending meetings with them when we need you to.
- Don't refund the bond to your *tenant* if they're potentially legally liable for any *loss* you're claiming, and you can lawfully withhold some or all of the bond.

#### If you don't fulfil these responsibilities

If you don't fulfil the responsibilities outlined above, we may:

- reduce the amount we pay you
- refuse to pay, or decline, your claim
- require you to pay back to us anything we've paid for the claim.

### What you must do to help us settle your claim

#### Obtain our permission before you incur expenses or negotiate claims

You must obtain our written permission before you incur any expense or negotiate, pay, settle, admit, reject, or make any agreement about any claim.

#### We will act in your name

In your name, we can:

- take any proceedings necessary to use your legal right of recovery from anyone else
- take over, defend, and settle any claim against you for *damages*.

If we act in your name, we'll do so at our expense. You must provide all reasonable help and cooperation, at your cost.

#### We will share and collect information about your claim

You allow us to share information with third parties about any claim you make under this policy. You also allow us to get information from third parties that's relevant to any claim you make under this policy.

#### You must complete documents agreeing settlement

Before we settle your claim, you must complete documents describing our settlement for your claim.

## **Excess – you will have to pay an excess**

The *excess* is the amount you must pay towards the cost of any claim.

The *excess* forms the first part of any *loss* you're claiming for.

We'll take the *excess* away from the amount of your claim, not from any policy limit.

If *loss* arises from multiple incidents, occasions, or events, the *excess* (or each relevant *excess*) applies to each incident, occasion, or event that causes *loss*.

### **One event, one excess**

Usually, you'll pay an *excess* for every claim. However, if you need to claim under more than one policy with us for *loss* caused by a single event at the same location, you'll only pay one *excess*. This will be the largest applicable *excess* of all your policies.

### **Different types of excess can apply**

More than one type of *excess* could apply – the specific circumstances of your claim will determine the total value of the *excess* you need to pay. If more than one type of *excess* applies, they'll apply cumulatively – they'll be added together to reach the total *excess*. Any amount shown on your *schedule* or described in this policy wording as an *excess* could apply.

The following additional *excesses* apply, unless the *loss* arises from fire, *flood*, or *natural hazard*.

- \$250 for each event, if you let your *home* to *tenants* other than you.
- \$1,000 for each event, if you make your *home* available to anyone for casual use in return for any form of payment.

## How we settle your claim under Cover Option – Maxi

If your *home* suffers a *loss* which we accept under this policy, we may choose to settle your claim in one of the following ways. No matter what we choose, we'll only pay up to the *home sum insured*.

If your *schedule* shows a *sum insured* for other parts of your *home*, the maximum we'll pay for those parts is the specific *sum insured* for them on your *schedule*.

### 1. Repair or rebuild your home

We'll repair or rebuild your *home* to the *replacement condition*.

We'll decide the best way to advance your claim, including inspecting any damage, choosing the repairer, and arranging the repair.

If we choose to repair your *home*, we'll get independent quotes from our approved repairers or suppliers. You can recommend repairers or suppliers to provide quotes for us to consider. We'll choose who will repair your *home*, oversee any repairs, and keep you up to date with what's happening.

### 2. Pay up to the replacement cost, to repair or rebuild your home

We'll pay up to the *replacement cost* to let you repair or rebuild your *home*. We'll only pay after you've incurred that cost. You must keep us up to date about the repair or rebuild. We can inspect the repair or rebuild and any relevant documents at any time.

### 3. Pay up to the replacement cost

We'll pay up to the *replacement cost* we believe you'll incur within 12 months. Before we choose this option, you must agree with us on the terms outlining how you will secure our payment until you incur the cost.

### 4. Pay the replacement cost to rebuild somewhere else

We'll pay up to the *replacement cost* to let you to build a *home* somewhere else. We won't pay for any extra costs associated with building at that location. You must finish building within 12 months unless we agree to extend that time. You must keep us up to date about the build. We can inspect the build and any relevant documents at any time.

### 5. Pay the replacement cost to buy a home somewhere else

We'll pay up to the *replacement cost* to let you to buy a *home* somewhere else within 12 months. You must agree with us on the terms outlining how you will secure our payment until you incur the cost.

### 6. Pay the indemnity value

We'll pay the *indemnity value* where you don't intend to repair or rebuild within 12 months unless we agree to extend that time.

### 7. We'll pay your mortgagee then settle any remainder

We'll first pay any part of the *replacement cost* to any mortgagee or party with a secured financial interest in your *home*. If there is any remaining part of the *replacement cost* after this payment, we will settle it by choosing one of the options above.

## There are some limits on what we'll pay

### We'll reduce the sum insured if you haven't repaired, replaced, or rebuilt previous losses

The *sum insured* will be reduced from the sum on your *schedule* by the amount needed to repair, replace, or rebuild any *loss* which occurred in any previous *period of insurance*.

This only applies where you haven't repaired, replaced, or rebuilt a *loss* that happened in a previous *period of insurance*.



### We'll pay up to \$50,000 for roads, lanes, and bridges

We'll pay up to \$50,000 for your share of incurred costs during the *period of insurance*, for *loss* to any private:

- road
- lane
- right-of-way
- access way
- bridge, including a bridge within the *residential boundaries* of the property your *home* is on
- guttering, drains, piping, cables, and lighting associated with any of the above.

We'll pay if the structures listed above provide access to a driveway that you own or share with other homeowners and you are responsible for.

### We'll top up the cover for bridges provided by NHC

If *loss* to a bridge arises from *natural hazard*, we'll pay up to the \$50,000 limit above in addition to the cover provided by the Natural Hazards Insurance Act 2023 (the NHI Act).

Toka Tū Ake Natural Hazards Commission (NHC) must have done both of the following:

- accepted liability for your claim for damage to the bridge
- already paid the maximum entitlement under the NHI Act for the *loss*.

### If damaged items are part of a group, we'll only pay for those damaged items

If items that suffer *loss* are part of a group of *similar items*, we'll only pay for those items that actually suffered *loss*. We'll pay up to the value of those items, or the cost to replace them.

We don't have to exactly replace, repair, or rebuild items that have suffered *loss*.

### Repairs to your kitchen

We'll repair the damaged areas of your kitchen and any undamaged areas that are considered part of the same section because they are continuously joined, are on the same level and made of the same materials.

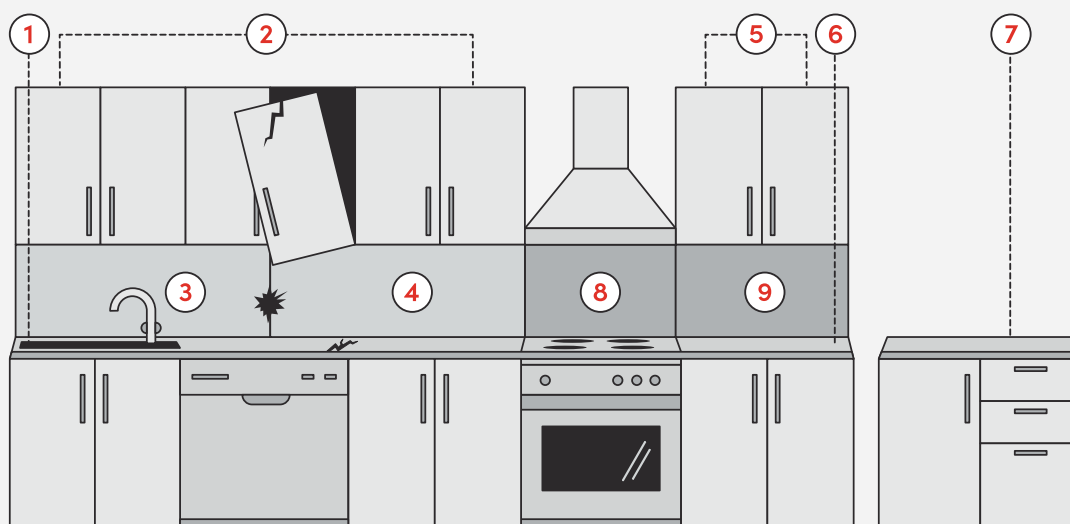

In this example we would replace the long bench up to the stove (1), the overhead cupboards (2) and both glass splash backs (3 & 4).



In this example we would not replace overhead cupboards (5), the separate bench tops (6 & 7), or the glass splash backs (8 & 9) as these are considered separate sections.

## We'll only replace wallpapers, floor coverings and curtains in the room where the loss happens

We'll only replace damaged wallpaper, floor coverings, drapes, curtains, and blinds in the *room* where the *loss* happened.

### Floor coverings

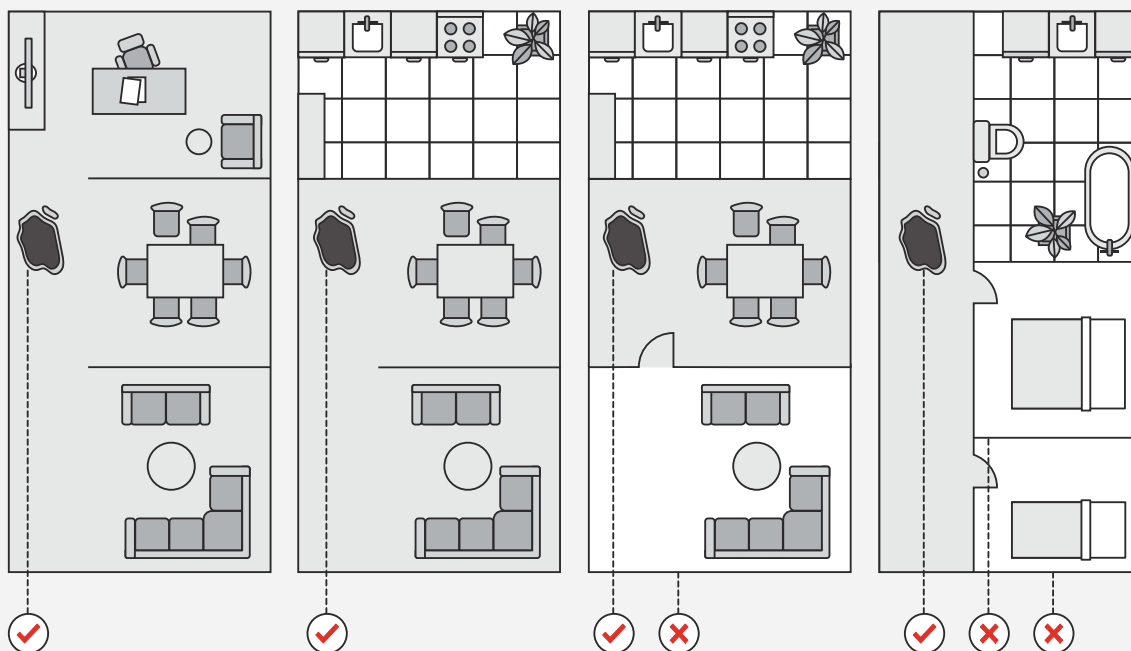

As all the rooms are open plan and all have the same floor covering, we would replace the floor covering in all three rooms.

As the two rooms are open plan, we would replace the floor covering in both rooms.

As there is a door between the two rooms, we would replace only the floor covering in the dining room.

In this case, we would replace the hallway floor covering only.

### We won't pay to comply with heritage covenants

If your *home* is registered with the Heritage New Zealand Pouhere Taonga, we won't pay any extra costs or fees needed to comply with any heritage covenants that apply to your *home*.

### We won't pay to repair land beneath damaged driveways

If an area of driveway suffers damage, we'll only pay to repair the base, the top layer, or both. We won't pay to repair the land beneath the driveway.

### We'll pay the indemnity value for older floor coverings

If you don't live in your *home*, we'll only pay the *indemnity value* for any fixed floor coverings over 5 years old. A fixed floor covering includes if it's floating, glued, tacked or smooth-edged.

### We'll pay the indemnity value for older shade sails

We'll only pay the *indemnity value* for outdoor shade cloth or fabric (shade sails) over 5 years old.

## Costs we'll pay that are associated with your claim

We'll pay the following costs out of your *sum insured*.

### Professional fees and clearance costs

We'll pay the following reasonable costs if they are necessary for the building work needed to repair or rebuild your *home*.

- Costs you incur from demolishing the damaged part of your *home*, clearing the building site, and removing any debris from your *home*.
- Fees you incur for the service of architects, surveyors, consultants, lawyers, and council. The fees must be directly necessary to repair or rebuild your *home* following any *loss* this policy covers. You must get our permission before you incur these fees. This does not include costs which would not usually be required to enable building work of the type required for the repair or rebuild to proceed.

### Statutory requirements – we'll pay to make your home compliant

When we pay to rebuild or repair your *home*, we'll pay the costs required to repair or rebuild the damaged portion of the *home* that is needed solely to comply with government or local authority statutes, by-laws and regulations ('the cost of compliance').

We'll only pay these costs if all the following apply.

- You didn't know about, or you had not been served with notice of, the *home* failing to comply with the statutes, by-laws, or regulations before the *loss* happened.
- An entry has not been made on your Certificate of Title under section 36 of the Building Act 1991, or section 74 of the Building Act 2004. However, we'll provide cover relating to the entry if we had agreed in writing before the *loss* happened.
- The costs don't relate to design issues that this policy excludes under the 'Home defects' exclusion on page 26.
- The damaged part of the building complied with relevant statutes, by-laws, or regulations when it was built, and whenever it was altered. If it didn't comply at those times, it had since been certified as compliant.

We'll only pay the cost of compliance:

- for the part of your *home* that has suffered physical damage that this policy covers
- that relates solely to repairing that *loss*.

We won't pay:

- the cost of compliance for any undamaged part of the *home*, whether or not it complies with statutes, by-laws, or regulations
- any extra costs or fees needed to comply with heritage covenants on your *home*, if it's registered with the Heritage New Zealand Pouhere Taonga
- to repair, prepare, stabilise, or treat the land if that's necessary to comply with regulations to allow repair or rebuilding of your *home*.

## The maximum we'll pay for your claim

The most we'll pay under this policy is the following list, added together.

- The *sum insured* shown on your *schedule* (including benefits paid from within it).
- Any GST that you've paid or is payable on the *sum insured*.
- Any amounts we are required to pay under these benefits:
  - Alternative accommodation (page 6)
  - Environmental improvements (page 7)
  - Landscaping (page 8)
  - Property owner's liability (page 11)
  - Stress payment (page 13)
  - SumExtra (page 14)
  - Optional benefit – Landlord's extension (page 15), if your *schedule* shows that you have this benefit.

## How we settle your claim under Cover Option – Flexi

If your *home* suffers a *loss* that we cover under this policy, we'll pay the *indemnity value* of your *home*, up to the *sum insured*.

### There are some limits on what we'll pay

#### We'll reduce the sum insured if you haven't repaired, replaced, or rebuilt previous losses

The *sum insured* will be reduced from the sum on your *schedule* by the amount needed to repair, replace, or rebuild any *loss* which occurred in any previous *period of insurance*.

This only applies where you haven't repaired, replaced, or rebuilt a *loss* that happened in a previous *period of insurance*.

#### We'll pay up to \$50,000 for roads, lanes, and bridges

We'll pay up to \$50,000 for your share of incurred costs during the *period of insurance*, for *loss* to any private:

- road
- lane
- right-of-way
- access way
- bridge, including a bridge within the *residential boundaries* of the property your *home* is on
- guttering, drains, piping, cables, and lighting associated with any of the above.

We'll pay if the structure listed above provides access to a driveway that you own or share with other homeowners and you are responsible for.

#### We'll top up the cover for bridges provided by NHC

If *loss* to a bridge arises from *natural hazard*, we'll pay up to the \$50,000 limit above in addition to the cover provided by the Natural Hazards Insurance Act 2023 (the NHI Act).

Toka Tū Ake Natural Hazards Commission (NHC) must have done both of the following:

- accepted liability for your claim for damage to the bridge
- already paid the maximum under the NHI Act for the *loss*.

#### If damaged items are part of a group, we'll only pay for those damaged items

If items that suffer *loss* are part of a group of *similar items*, we'll only pay for those items that actually suffered *loss*. We'll pay up to the value of those items, or the cost to replace them.

We don't have to exactly replace, repair, or rebuild items that have suffered *loss*.

## Repairs to your kitchen

We'll repair the damaged areas of your kitchen and any undamaged areas that are considered part of the same section because they are continuously joined, are on the same level and made of the same materials.

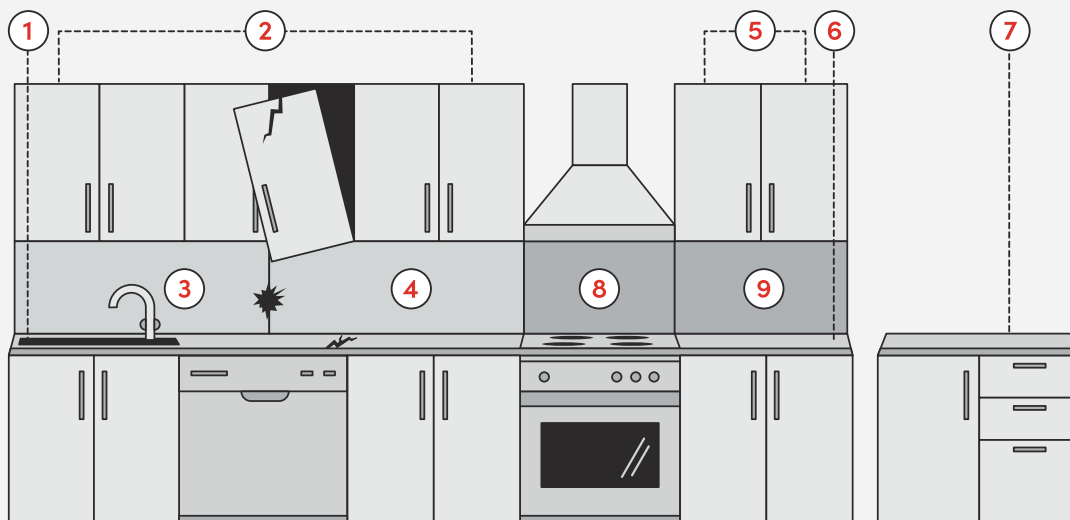

In this example we would replace the long bench up to the stove (1), the overhead cupboards (2) and both glass splash backs (3 & 4).



In this example we would not replace overhead cupboards (5), the separate bench tops (6 & 7), or the glass splash backs (8 & 9) as these are considered separate sections.

## We'll only replace wallpapers, floor coverings and curtains in the room where the loss happens

We'll only replace damaged wallpaper, floor coverings, drapes, curtains, and blinds in the *room* where the *loss* happened.

### Floor coverings

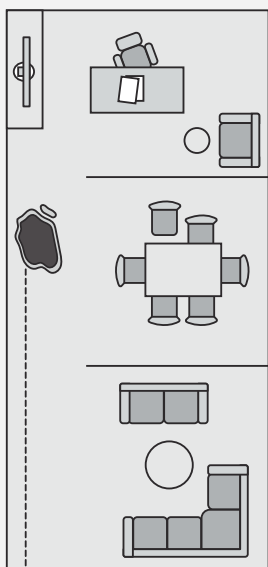

As all the rooms are open plan and all have the same floor covering, we would replace the floor covering in all three rooms.

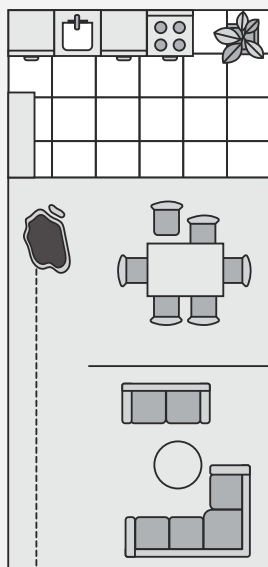

As the two rooms are open plan, we would replace the floor covering in both rooms.

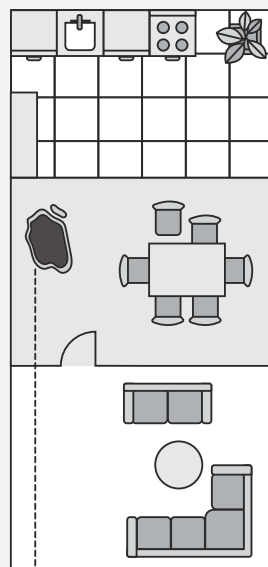

As there is a door between the two rooms, we would replace only the floor covering in the dining room.

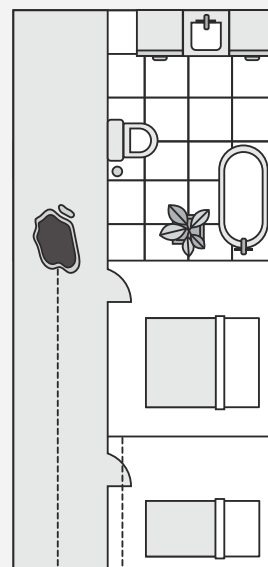

In this case, we would replace the hallway floor covering only.

### **We won't pay to comply with heritage covenants**

If your *home* is registered with the Heritage New Zealand Pouhere Taonga, we won't pay any extra costs or fees needed to comply with any heritage covenants that apply to your *home*.

### **We won't pay to repair land beneath damaged driveways**

If an area of driveway suffers damage, we'll only pay to repair the base, the top layer, or both. We won't pay to repair the land beneath the driveway.

## **Costs we'll pay that are associated with your claim**

We'll pay the following costs out of your *sum insured*.

### **Professional fees and clearance costs**

We'll pay the following reasonable costs if they are necessary for the building work needed to repair or rebuild your *home*.

- Costs you incur from demolishing the damaged part of your *home*, clearing the building site, and removing any debris from your *home*.
- Fees you incur for the service of architects, surveyors, consultants, lawyers, and council. The fees must be directly necessary to repair or rebuild your *home* following any *loss* this policy covers. You must get our permission before you incur these fees. This does not include costs which would not usually be required to enable building work of the type required for the repair or rebuild to proceed.

### **Statutory requirements – we'll pay to make your home compliant**

When we pay to rebuild or repair your *home*, we'll pay the costs required to repair or rebuild the damaged portion of the *home* that is needed solely to comply with government or local authority statutes, by-laws and regulations ('the cost of compliance').

We'll only pay these costs if all the following apply.

- You didn't know about, or you had not been served with notice of, the *home* failing to comply with the statutes, by-laws, or regulations before the *loss* happened.
- An entry has not been made on your Certificate of Title under section 36 of the Building Act 1991, or section 74 of the Building Act 2004. However, we'll provide cover relating to the entry if we had agreed in writing before the *loss* happened.
- The costs don't relate to design issues that this policy excludes under the 'Home defects' exclusion on page 26.
- The damaged part of the building complied with relevant statutes, by-laws, or regulations when it was built, and whenever it was altered. If it didn't comply at those times, it had since been certified as compliant.

We'll only pay the cost of compliance:

- for the part of your *home* that has suffered physical damage that this policy covers
- that relates solely to repairing that *loss*.

We won't pay:

- the cost of compliance for any undamaged part of the *home*, whether or not it complies with statutes, by-laws, or regulations
- any extra costs or fees needed to comply with heritage covenants on your *home*, if it's registered with the Heritage New Zealand Pouhere Taonga
- to repair, prepare, stabilise, or treat the land if that's necessary to comply with regulations to allow repair or rebuilding of your *home*.

## The maximum we'll pay for your claim

The most we'll pay under this policy is the following list, added together.

- The *sum insured* shown on your *schedule* (including benefits paid from within it).
- Any GST that you've paid or is payable on the *sum insured*.
- Any amounts we are required to pay under these benefits:
  - Alternative accommodation (page 19)
  - Landscaping (page 19)
  - Property owner's liability (page 20)
  - Optional benefit – Landlord's extension (page 22), if your *schedule* shows that you have this benefit.

## What your responsibilities are

This section outlines the responsibilities you, and anyone else insured under this policy, must meet.

### Information given to us must be correct

Your proposal, application, or declaration form is the basis of this contract.

All statements and information you give us, or anyone gives us on your behalf, must be complete and correct. This includes statements and information:

- in any proposal, application, or declaration – whether we get the statements and information verbally, electronically, or in printed form
- that support this policy or any claim.

If you give incorrect or false information in relation to your claim, or if your claim is fraudulent in any way, we won't pay the claim. If your claim is fraudulent, your policy automatically ends – we will cancel your policy from the date you made the claim or gave us the false information.

If you give us incorrect or incomplete information, or if information is withheld, and your claim is declined or we *avoid* your policy, this may affect your ability to obtain insurance in the future.

### You have a duty of disclosure

You have a duty of disclosure, which means you must tell us everything we'd consider material to decide:

- whether to issue, renew, or change this policy
- the terms on which we'd issue, renew, or change this policy, including the *premium* we charge.

Your duty of disclosure applies each time you renew or change this policy. If you don't meet your duty of disclosure, we can refuse a claim, reduce any claim payment, or *avoid* the policy. This may affect your ability to obtain insurance in the future.

### Tell us if anything changes

Tell us straight away if there's a change that could affect your cover, our decision to insure you, or the *premium* we charge. Some examples of when you might need to do this are:

- you sell your *home*, or buy a new one
- you make structural changes or additions to your *home*
- you're going to leave your *home unoccupied*
- you or someone living with you is convicted of a criminal offence
- Toka Tū Ake Natural Hazards Commission (NHC) has provided:
  - you with written notice of cancellation of cover for your *home*
  - you with written notice of limitation of liability for future damage to your *home*
  - the Registrar-General of Land with written notice of cancellation or limitation of liability and a certificate of cancellation or limitation of liability has been registered on the record of title for your *home*.

If you're not sure whether something is important, tell us anyway. If you don't keep us up to date, we can refuse a claim, or reduce any claim payment, or *avoid* the policy.

### If we avoid your policy

If we *avoid* your policy, we treat it as though it never existed. You will have to pay back any claim payments we have made to you, and we will refund you any *premium* you have paid to us.

This might mean you find it difficult to get other insurance in the future.



## You're responsible for setting your sum insured

The *sum insured* is the figure you estimate as the total cost of rebuilding your *home*, including all associated costs. It is not the value of your property on the open housing market.

You must review your *sum insured* regularly, as it's your responsibility to ensure you have enough insurance cover to rebuild your whole *home* if you need it.

## You must take all reasonable steps to prevent loss

You must, at your cost or expense, take all reasonable steps to prevent *loss* and keep the *home* covered by this policy in good condition. We always have the right to examine property this policy covers.

You must also try to avoid any *loss* that you could be held legally liable for.

We won't cover *loss* or legal liability in the event that you are reckless or grossly negligent.

Reckless or grossly negligent means you've failed to act in the way a reasonable person would, given the circumstances you faced when the *loss* happened.

## If you're paid reparation, you may need to pay it to us

If anyone covered by this policy is paid *reparation* for *loss* to property that we are paying (or have paid) a claim for, you must tell us. You must give us the *reparation* payments to repay the claim payments that we have made, up to the amount of the *reparation* received.

## You can't pass on your rights or interests under this policy

Without our prior written agreement, you can't assign, or attempt to assign, either of the following to any other party:

- this policy or your interest in it
- your rights to any claims proceeds under this policy.

## Landlord obligations – responsibilities you must meet if your home is tenanted

If your *home* is *tenanted*, you must meet the responsibilities below. If you don't meet all of these, we can refuse to pay your claim.

### Select tenants with care

You or your managing agent must take all reasonable care when choosing each *tenant*. This includes:

- obtaining satisfactory written references for each adult *tenant* before that *tenant* moves into your *home*
- keeping records of checks you make and references you obtain, and giving them to us if we ask for them.

### Inspect your property every time the tenancy changes and at least once every 6 months

You or your managing agent must inspect the property inside and out, both:

- whenever the *tenant* changes
- every 6 months, at a minimum.

You or your managing agent must also keep photos and written records of the condition of the property at the time of the inspection, and give them to us if we ask for them.

### You have additional obligations if you've chosen Landlord's extension

If you have purchased the optional 'Landlord's extension' benefit, you must also meet the following additional responsibilities.

**Actively monitor the rent, and take steps to get overdue rent paid**

You or your managing agent must do all the following.

- Actively monitor the *rent* for your *home*.
- Give written notice to the *tenant* if the *rent* is 10 days overdue, requiring them to pay that *rent*.
- If the unpaid *rent* is not received within a further 5 days, both:
  - personally deliver a second notice to the *tenants* requiring them to pay that *rent*
  - find out whether your *tenants* are still living at your *home*.

**Find new tenants as soon as possible**

You must mitigate any loss of *rent* by taking all reasonable steps to find suitable new *tenants* as quickly as possible. You must give us records of the steps you took if we ask for them.

# Policy conditions and other important information

## Your premium

Your *premium* is the payment you make in exchange for your insurance cover. Your *premium* is detailed on your policy documentation.

### Paying your premium

Your insurance policy is an annual contract. You can choose to pay annually in full, or in instalments.

Your *premium* will be higher if you pay by anything other than annual instalments, as we charge you instalment fees.

Making changes to your policy details may affect the *premium* you need to pay or have paid for the remainder of your *period of insurance*.

If you pay annually and don't pay the full amount, we may reduce the *period of insurance* to align with the amount you paid.

### Your premium must be paid up to date before we'll pay a claim

If you need to make a claim and you have *premium* that is less than 28 days overdue, we may do one of these things:

- withhold the claim payment until you've paid the overdue *premium*
- deduct the overdue *premium* from the claim payment.

### Your policy ends if your premium is more than 28 days overdue

If your *premium* is overdue by more than 28 days, your insurance cover under this policy ends. Cover stops from the date you have paid up to.

## Your cover reduces after a claim, before repairs are done

If we pay a claim for *loss* under this policy, your policy continues. However, the amount of cover available to pay future claims out of the *sum insured* reduces by the value of the *loss*.

We restore the amount of cover in line with the repair or rebuilding of the *loss*. But before we can restore the amount of cover, both of the following things must happen.

- You must pay any extra *premium* that we may charge.
- We must be satisfied that the *sum insured* shown on your *schedule* is a reasonable estimate of the cost of repairing or rebuilding the entire *home*.

We'll only restore your cover once during the *period of insurance*, unless we agree otherwise in writing. We won't restore your cover if there's been a *total loss* under this policy.

## How your policy can be cancelled

### You can cancel your policy

#### You have a cooling-off period if you change your mind

When you first purchase this policy, you can cancel it within 30 days if you change your mind. We'll refund all the *premium* you've paid if you haven't made a claim.

#### You can cancel after the cooling-off period

You can cancel your policy at any time after the 30-day cooling-off period. If you haven't made a claim, we'll refund any *premium* you have already paid for insurance cover after the cancellation date.

## **We can cancel your policy**

### **We can write to you to cancel your policy**

We can cancel this policy at any time by writing to either:

- you at the address or email address on our records
- your insurance adviser.

Your policy will be cancelled from 4.00pm on the 14th day after we send the letter. We will refund any *premium* you've already paid us for cover after the effective date of the cancellation.

### **We'll cancel your policy if you make a fraudulent or false claim**

If you make a fraudulent or false claim, this policy automatically ends. We don't need to cancel it in writing, but we may confirm to you in writing that it was automatically cancelled at a particular time. We refund any *premium* you have already paid for cover after the cancellation date.

## **We may automatically adjust sum insured at renewal**

When we renew your policy, we consider factors that can influence the cost of repairing, rebuilding, or other costs.

As a result, we may adjust the *sum insured* for your *home*. If we do, we'll show your new *sum insured* on your *schedule*, and adjust your *premium* accordingly.

We don't guarantee, represent or advise that any change to your *sum insured* will be enough to compensate you fully for any *loss*. You must always ensure your *sum insured* is enough to cover *loss* to your *home*, and associated costs.

## **We don't cover you if you breach these terms**

To be covered under your policy, you must comply with the terms and conditions outlined in this policy wording.

If we find that anyone insured by your policy has breached any of these terms or conditions, we can decline a claim, or reduce the payment.

However, nothing in this policy wording affects our rights or yours under common law, including our right to *avoid* your policy for not making full disclosure in accordance with your duty of disclosure.

## **This policy can cover multiple parties as joint insureds**

This policy is a joint policy if your *schedule* shows joint names, or includes the name of a Trust, as being insured.

We view each insured person as acting with the explicit permission of any other. You each have the right to change this policy, make or settle a claim under this policy, or cancel this policy.

Any breach of the policy terms or conditions by one person will prevent all insured people from claiming under this policy.

## **We may change the terms of this policy**

If we can no longer obtain or retain full reinsurance protection from any *natural hazard* this policy covers, we may change the terms of this policy including the *excess*.

We'll send a letter or e-mail to the latest address we have for you, or to your insurance adviser. The change takes effect at 4.00 pm on the 14th day after we send the letter.

## How GST applies when we pay a claim

In this policy, GST is included in dollar figures for:

- benefits
- excesses
- limits to items.

However, we'll pay GST that is paid or payable on top of the *sum insured*.

## Benefit limits that are based on a percentage of the sum insured

Where a benefit limit refers to a percentage of your *sum insured*, this is based on your *sum insured* excluding GST.

## We only pay once if more than one benefit could apply

Some benefits under this policy can only be used once per event, even if you have more than one policy or section of a policy with us that has the same benefit.

This condition applies if you, or someone you live with, has any of the following benefits with us under more than one policy:

- Alternative accommodation
- Property owner's liability
- Resetting or reprogramming a security system
- Stolen keys
- Stress payment

## We don't cover you if you have other insurance

We won't cover you for *loss* or liability where insurance cover is provided by another insurer for the same *loss* or liability. We won't contribute towards any claim under any other policy.

## If your property is secured by an interested party

If your property is mortgaged, or secured by another kind of financial agreement, we may make any claim payment to the interested party. This will meet our responsibilities under this policy.

Where required, we'll share personal information about you with any party that holds a financial interest in your property.

We don't cover parties with a financial interest under this policy, and those parties can't make claims.

## New Zealand law applies to this policy

This policy is governed by New Zealand law and New Zealand courts have exclusive jurisdiction over any legal proceedings about it.

When this policy mentions an Act of New Zealand Parliament, this includes any substitution, amendment, or replacement of the Act. If the Act has been repealed and there is no substitution or replacement, we mean any part of an Act with substantially the same purpose and function. It includes the regulations under the Act.

## How Government Natural Hazards Cover works when you insure more than one site

If your policy covers property at more than one named location, each location is considered a separate insurance policy for the purposes of the Natural Hazards Insurance Act 2023.

### **We'll cover your home until it changes hands**

If you've signed a contract to sell your *home*, we'll cover the buyer under this policy until they take possession of your *home* or until settlement, whichever is earlier. However, we only cover the buyer if they're not covered under another policy.

The limitations, exclusions, conditions, and cover limits of this policy apply to both you and the buyer, as if you were jointly insured.

### **We'll put details of your claims on the Insurance Claims Register**

In buying this policy, you allow us to put details of any claims you make on the Insurance Claims Register (ICR) so other insurers can see them. You also allow us to obtain personal information and details of claims you've made from the ICR.

The ICR is a database of insurance claims. It helps prevent insurance fraud by enabling insurance companies to share details of claims. The ICR is operated by Insurance Claims Register Limited (ICR Ltd), PO Box 474, Wellington 6140.

## Definitions

This section defines some words and phrases that have specific meanings in this policy wording. When we use the words or phrases below, we use *italics*, and we mean the definition we give in this section.

### ***Accident, accidental, and accidentally***

A sudden and unforeseen event not intended or expected by you.

### ***Avoid (a policy)***

We'll treat your policy as though it never existed in accordance with the legal principles which govern the duty of disclosure and its remedies.

### ***Award (relating to the Health and Safety at Work Act 2015)***

Any of the following imposed by a New Zealand Court in relation to prosecution against you under the Health and Safety at Work Act 2015:

- *damages*
- restitution
- compensation
- reparation order.

Award does not include:

- any payment that is unlawful to insure against
- fines, penalties, or infringement fees under the Health and Safety at Work Act 2015.

### ***Bodily injury***

Bodily injury (including death), illness, disability, disease, shock, fright, mental anguish, or mental injury to another person.

### ***Computer system***

Any of the following in any configuration:

- computers, hardware, and software
- communications systems
- electronic devices, including smart phones, laptops, tablets, and wearable devices
- electronically controlled equipment, including data processing equipment
- server, cloud, or microcontroller equipment
- any similar system, input, output, data storage device, networking equipment or back up facility.

### ***Contents***

Anything in your:

- possession or located at the *home*, belonging to you or hired by you
- custody or control for which you are responsible, that is not insured elsewhere.

Contents doesn't include any of the following.

- Mechanically propelled vehicles, trailers, caravans, or aircraft (except ride-on mowers and other domestic garden appliances, children's battery-powered or mechanically propelled motor toys up to 50cc, electric wheelchairs and electric mobility aids, *drones*, and remote-controlled scale models).
- Vehicle accessories in or on a vehicle.
- Vehicle keys or vehicle remote controls.

- Entertainment, navigation, and communications systems and radar detectors that are in or on a vehicle, including any parts that attach to these systems.
- Trees, shrubs, and plants (other than pot plants).
- Fixtures, fittings, sculptures, or artwork (and their accessories) permanently attached to the *home* or to land.
- Contents used in any way for professional or business purposes.
- Contents normally housed in an address not named on the *schedule*.
- Any item of contents that you have sold, gifted, or given away, that is no longer in your possession, or any item which you have taken ownership of or responsibility for, but you have not yet taken possession of.
- Any artificial body parts, surgical implants, or attachments that are permanently fitted to you or to any animal.
- Any animal.
- The *home*.

### **Cyber act**

One or more unauthorized, malicious, or criminal acts involving accessing, processing, using, or operating any *computer system*. Cyber act also includes the threat or hoax of these acts.

### **Cyber incident**

Either of the following.

- Any error, omission or series of related errors or omissions involving accessing, processing, using, or operating any *computer system*.
- Any partial or total unavailability or failure, or recurring unavailability or failure of involving accessing, processing, using, or operating any *computer system*.

### **Damages**

Money you have to pay because of a judgment against you, or a settlement we negotiate. Damages can include the other party's costs, and interest.

Damages does not include:

- punitive or exemplary damages
- *reparation*
- fines
- taxes
- any other kinds of penalty or compensation, financial or not
- any other payment that is unlawful to insure against.

### **Data**

Any kind of information, including facts, concepts, or code.

In this definition, we mean information that is converted, recorded, or transmitted in a form that a *computer system* can access, communicate, display, distribute, interpret, process, transmit, store or use.

### **Domestic pets**

Any animal that's tamed and kept for pleasure and companionship. It doesn't include any animal that is:

- not usually found living in urban households
- kept as a working or sporting animal
- kept for breeding or for any economic purpose.



**Drone(s)**

Any aerial device that's unmanned, unpowered, and remotely operated that is compliant with, and used in accordance with, the Civil Aviation Rules.

**Excess(es)**

The amount you must pay towards the cost of any claim.

**Flood**

The inundation of land by water that has either:

- escaped or been released from the normal confines of the sea, a watercourse, reservoir, pond, dam, or lake
- run off, accumulated, or pooled.

This definition does not apply if it is only your property that is inundated.

**Healthcare practice**

The part of your *home* that either:

- you exclusively use to carry on the business of a health practitioner, as defined by the Health Practitioners Competence Assurance Act 2003
- your customers use to access to that part of your *home*.

**Home**

The dwelling, including residential flat or holiday home, which is:

- owned by you
- used for *residential purposes*
- located within the *residential boundaries*
- at the address shown on your *schedule*.

Home includes the following items which are owned by you, used for *residential purposes*, and located within the *residential boundaries* of the address.

- Each additional self-contained dwelling unit capable of being lived in, and that you intend to be lived in, or that is being lived in by one or more persons (if your *schedule* specifically shows these additional dwelling units as part of your home).
- Any separate outbuildings that are not self-contained or capable of being lived in, and any garages.
- Permanent decks.
- Greenhouses and garden sheds, patios, pergolas, and built-in furniture.
- Aerials and satellite dishes that are attached to the home.
- Fixed floor coverings (floating, glued, tacked or smooth edged).
- Coverings fixed to the ceiling or wall.
- Curtains, drapes, and blinds.
- Fixed light fittings and appliances permanently wired or plumbed to a gas, plumbing, or electricity supply.
- Letter boxes, exterior blinds and awnings, fixed clotheslines, and built-in barbeques.
- Septic tanks, heating oil tanks, service tanks, water tanks, and their fixed pumps and systems.
- Permanent spa pools or swimming pools, including their fixtures, covers, pipes, and fixed pumps.
- Walls, fences, and gates.
- Solar power systems.
- Gas pipes, fresh-water pipes, underground drainage, and sewerage pipes.
- Cables and poles associated with electricity, *data*, and telephone services.

- Any driveways, paths, patios, bridges, paving, tennis courts, and permanently installed artificial grass or turf.
- Any private road, lane, right-of-way, access way, or bridge (including associated guttering, drains, piping, cables, and lighting) providing access to a driveway that you own, or share with other residential property owners, and for which you're responsible for.
- Permanently installed ornamental fishponds and water features connected to the dwelling's water supply.
- Sculptures and artwork that are permanently fixed to buildings or land.
- Your share in any walls (except retaining walls), fences, gates, pipes, cables, or driveways that you jointly own with other property owners.
- Any part of the *home* used as a *home office* or *healthcare practice*.

'Home' doesn't include any of the following.

- *Contents*.
- Temporary structures.
- Retaining walls, except for the cover provided under the Cover Option – Maxi 'Retaining walls' benefit (page 12).
- Power generation and power storage equipment, except for the cover provided under the Cover Option – Maxi 'Power generation equipment' benefit (page 10).
- Hedges, trees, shrubs, plants, lawns, and garden edging except where cover is provided under the 'Landscaping' benefit applicable to your Cover Option.
- *Landlord's furnishings*, unless your *schedule* shows you have the optional 'Landlord's extension' benefit.
- Any boarding house (as defined by the Residential Tenancy Act 1986).
- Wharves, piers, jetties, or similar structures.
- Culverts, ponds, dams, and slipways.
- Sea walls, *flood* walls, and levees.
- Other property owners' shares in any walls, retaining walls, fences, gates, pipes, cables, or driveways that you jointly own with those property owners.
- Land, earth, or fill.

### **Home office**

The part of your *home* that either:

- you exclusively use to do administrative, clerical, or professional business
- your customers use to access that part of your *home*.

### **Indemnity value**

One of the following.

- For a *total loss* – the market value of the *home* immediately before the *loss* occurred.
- For a *partial loss*, either:
  - the cost of repairing the damaged portion of the *home* to a condition no better or more extensive than it was when new, up to the market value. We'll subtract an amount for depreciation, age, and wear and tear
  - the reduction in value because of the *loss*, up to the market value.
- For *landlord's furnishings* (where your *schedule* shows you have the optional 'Landlord's extension' benefit), either:
  - the market value of the *landlord's furnishings*
  - the cost of replacing, repairing or reinstating *landlord's furnishings* to a condition no better or more extensive than when new, up to their market value. We'll subtract an amount for depreciation, age, and wear and tear.

In this definition, market value means:

- the market value of the *home*, excluding land, as determined by a registered valuer we've engaged
- what we deem to be the value of *landlord's furnishings* (where your *schedule* shows you have the optional 'Landlord's extension' benefit).

### **Landlord's furnishings**

The following items that you own in a *tenanted* property and are not permanently wired into the *home*.

- Dishwashers.
- Stoves.
- Refrigerators.
- Washing machines.
- Dryers.
- Built-in microwaves.

### **Loss**

*Accidental* physical loss or physical damage. It doesn't mean prevention of use or loss of functionality or usefulness.

### **Natural hazard(s)**

An earthquake, natural landslide, volcanic activity, tsunami, or hydrothermal activity – or fire resulting from any of these. It does not include a gradual or slow-moving natural landslide.

### **Period of insurance**

The timeframe we provide your insurance cover for (usually 12 months), as shown on *your schedule*.

### **Premium**

The amount you need to pay us to ensure cover commences and remains in force. This is the initial premium or any subsequent premium, and includes any government levies and taxes.

### **Rent**

The payments due to you from *tenants* for your *home* under the current *tenancy agreement*.

### **Reparation**

An amount a New Zealand court orders you to pay to the victim of an offence under section 32 of the Sentencing Amendment Act 2014.

Reparation does not include:

- reparation resulting from an offence under the Health and Safety at Work Act 2015
- *damages*, court costs, fines, any other kind of penalty (financial or not), taxes any payment that is unlawful to insure against
- your legal defence costs or expenses relating to an offence.

### **Replacement condition**

What we determine is reasonably required to rebuild your *home*. The rebuild amount will include rebuilding:

- to a building standard or specification similar to, but not more extensive or better than, the *home's* condition when new
- using techniques and building materials that are currently equivalent and readily available in New Zealand.

Replacement condition only includes replicating heritage features if it's possible with the techniques or building materials (or both) that are currently equivalent and readily available in New Zealand.

### **Replacement cost**

What we determine is reasonably required to repair or rebuild the damaged portion of the *home* to the *replacement condition*. The cost is calculated at the time of the *loss* that gives rise to a claim under this policy.

### **Residential boundaries**

The part of the land the *home* dwelling sits on, which you, members of your family, or your *tenants* mainly use for *residential purposes*.

Residential boundaries doesn't include any part of the land:

- which is used for commercial or farming purposes
- that's more than 150 metres away from a dwelling or garage used for *residential purposes*, if the *home* is both:
  - on a property larger than 10,000 square metres
  - not serviced by a dedicated town mains water supply.

### **Residential purposes**

The ordinary domestic activities of life – this doesn't include activities that have a business or commercial purpose.

### **Room**

Any room(s), common area(s), and passageway(s) openly connected and not separated by any doors, doorways, or stairs.

### **Schedule**

The policy schedule, policy change, endorsement, expiry notice, or renewal notice that we most recently issued to you or your insurance adviser.

### **Similar items**

Items in the *home* with a similar nature, use, colour, texture, material, or design. This includes items which form part of a set.

### **Sum insured**

The amount your *schedule* shows your *home* is insured for.

### **Tenancy agreement**

A written contract lasting for at least 90 days, giving the *tenants* the right to occupy your *home* in exchange for regularly paying *rent*.

### **Tenant, tenants**

The person (or people) who sign a *tenancy agreement* with you, including their spouse or partner and their family.

### **Tenanted**

Your *home* is occupied by *tenants* and your *schedule* shows your home is occupied by *tenants* or is a rental property.

### **Total loss**

We have declared that either of the following are damaged beyond economic repair.

- Your *home*.
- Your *landlord's furnishings*, if your *schedule* shows you have the optional 'Landlord's extension' benefit.

***Uninhabitable***

We, or government or local authorities, determine the *home* is no longer a safe or sanitary place to live because of physical damage to the *home* – and we or they have therefore given you notice of this.

Uninhabitable doesn't mean you or your *tenants* not wanting to live in an otherwise safe or sanitary *home*.

***Unoccupied***

No authorised person has slept overnight in the *home* within the last 60 days.

